



ACROVYN® WALL & DOOR PROTECTION

For experiences
that endure.

 Construction Specialties®

Helping you build *big dreams.*

We start with a simple promise: offer the highest quality service, products, and expertise to help the building industry create amazing places. And since 1948, we've done that by taking a listen-first approach to discover what you really need. That's led us to create innovative products, like the Acrovyn® line that revolutionised wall protection. It's also enabled us to not only solve problems but also to create opportunities to help you build better.





Leading *with excellence.*

We're always challenging ourselves to live up to your highest standards. So, when you find that what's out there doesn't work for you, we strive to create what does. That means we're not just ready but willing to change our products to fit your project. It's an approach that's helped set the bar for the industry and can help you realise a world of possibilities.

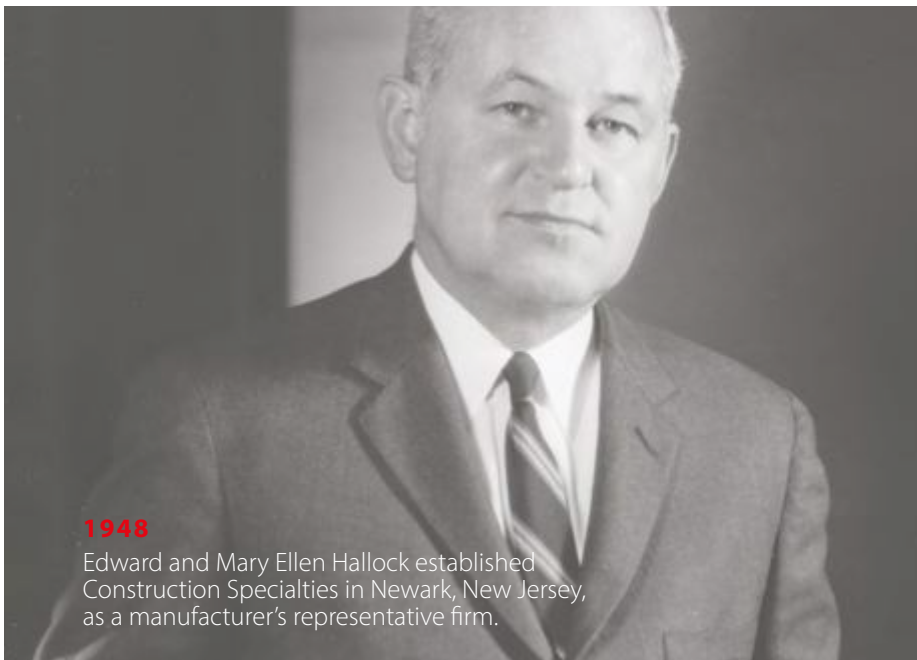

1948

Edward and Mary Ellen Hallock established Construction Specialties in Newark, New Jersey, as a manufacturer's representative firm.

70+

Years of excellence in the architectural products industry

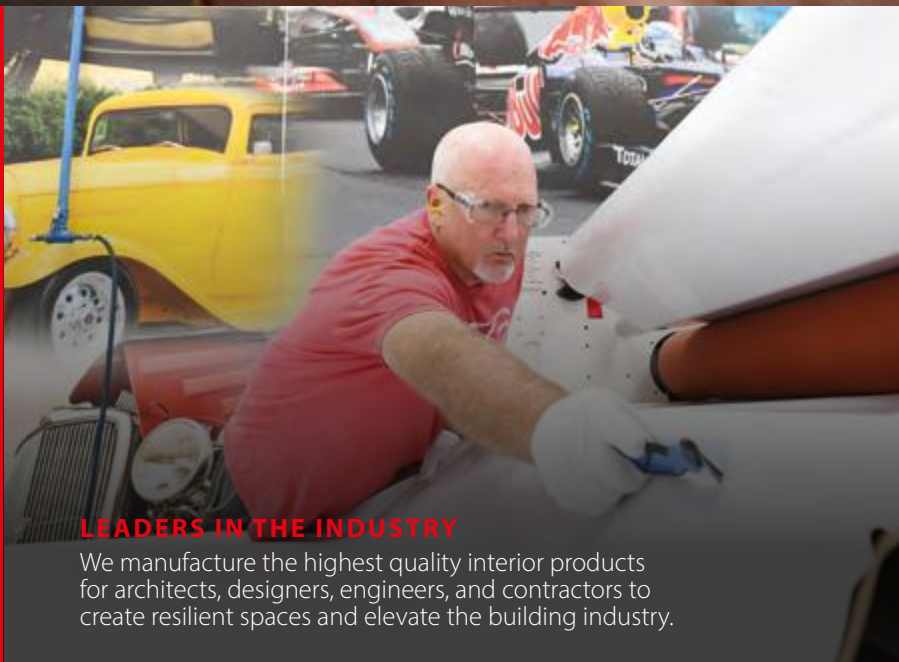

LEADERS IN THE INDUSTRY

We manufacture the highest quality interior products for architects, designers, engineers, and contractors to create resilient spaces and elevate the building industry.

Solutions from *the inside out.*

A beautiful building is just the beginning. Our goal is to partner with you to transform your project into a vibrant space that positively impacts its occupants – whether that means protection from the elements, making a visual statement, or anything in between. Let's make it memorable together.

ACROVYN WALL PROTECTION

ACROVYN DOOR PROTECTION

ENTRANCE FLOORING SYSTEMS

EXPANSION JOINT COVERS

ARCHITECTURAL LOUVRES

SUN CONTROL SOLUTIONS

PRESSURE RELIEF VENTING



View our full
product range:

c-sgroup.eu/28

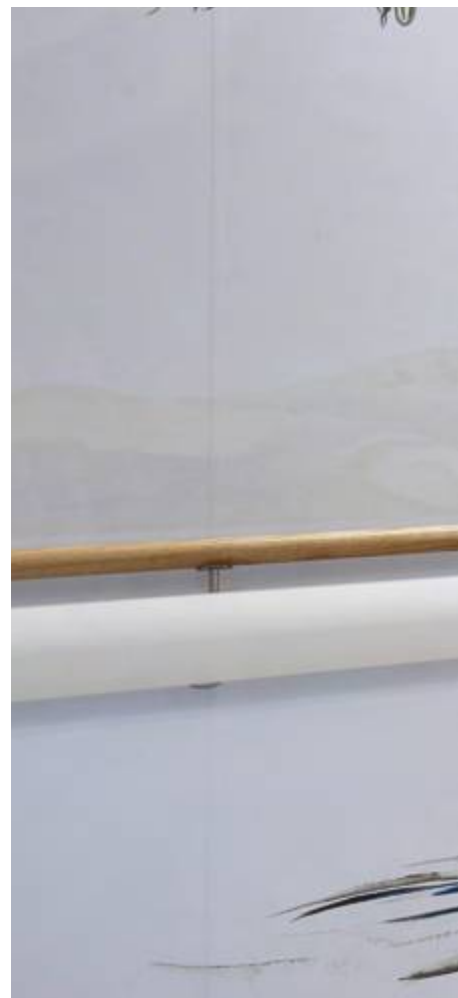
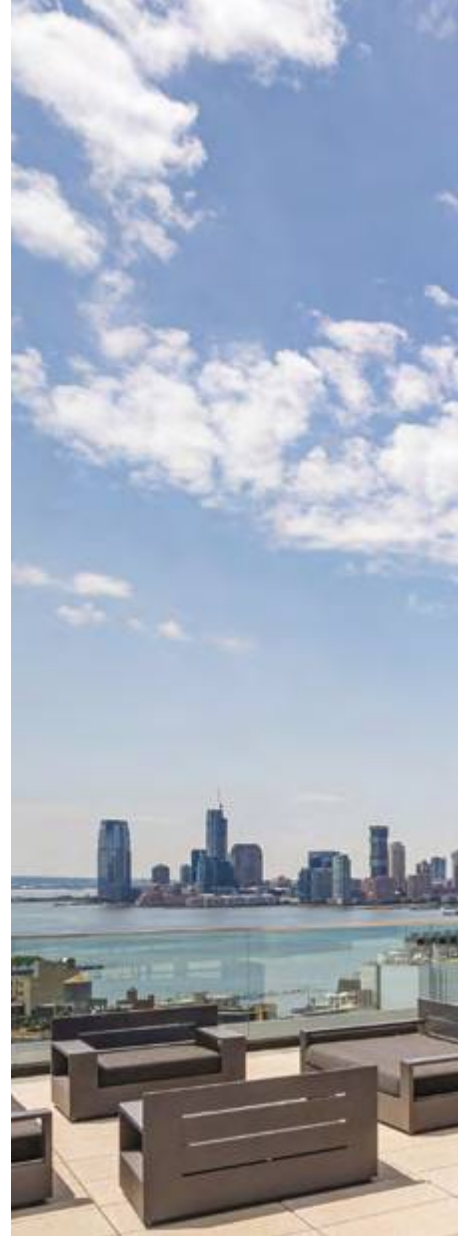



**412 WEST 15TH STREET
NEW YORK, US**
RAIN DEFENCE LOUVRES



**ROYAL ORTHOPAEDIC
HOSPITAL, LONDON, UK**
COMBINED HAND/CRASH RAILS
ACROVYN BY DESIGN
BED HEAD PROTECTION

INTERIOR PRODUCTS

Acrovyn®
Wall & Door Protection



The gift of choice.

Every project is unique, requiring different levels of protection, performance characteristics and design options. Whatever your needs and budget – we've got it covered.



SOLUTIONS FOR ALL BUILDINGS

From light duty rub rails for waiting rooms, durable wall and door finishes for all the busy areas in your building, or robust profiles capable of withstanding impact from wheeled equipment, the Acrovyn range makes it easy to create a complete interior protection scheme for any environment.



SAFE MATERIALS

All Acrovyn materials are free from persistent bio-accumulative toxins (PBTs), Bisphenol-A (BPA) and halogenated or brominated fire retardants. They don't contain any heavy metals and have achieved A+ Class rating when tested for the release of Volatile Organic Compounds (VOCs), allowing you to specify with confidence.



SUSTAINABLE CHOICES

Acrovyn PVC-Free is our most environmentally friendly material, proven to be as strong and durable as original Acrovyn.

Our current offering includes a wide selection of wall protection profiles, as well as Bronze Level *Cradle to Cradle Certified*® textured sheet.

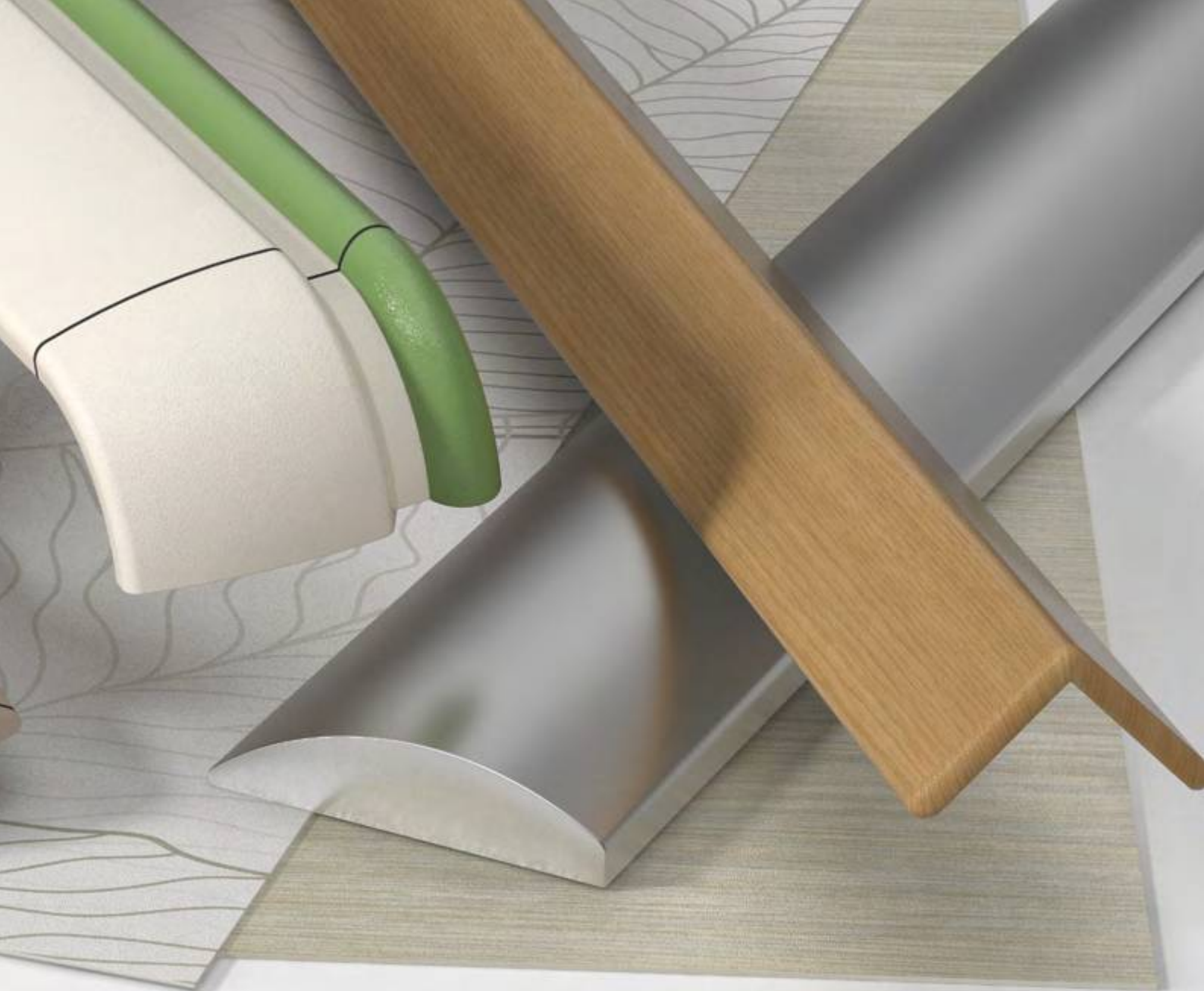

FIRE RATED SOLUTIONS

Compliance with fire regulations is one of the most important considerations for any building.

Where applicable, we have highlighted the fire ratings of our products to make it easy for you to choose the right solution for your space.



BACTERICIDAL SOLUTIONS

If infection control is your key concern, Acrovyn Bactericide will ensure long-term hygienic conditions.

Tested and proven effective against the most commonly occurring hospital and food bacteria species, Acrovyn Bactericide is available as sheets, handrails and bed head protectors.

NEED HELP SPECIFYING?

Browse our website for best practice guidance and project inspiration.



c-sgroup.eu/14233

Find *your style.*

With so many options to choose from, there's truly a look for everyone. Our Acrovyn® wall protection comes in a wide selection of neutral and vibrant solid colours, with some models available in woodgrain, brushed metal and concrete finishes, to help you fit every mood, desire, and vision.

Coordinate with Acrovyn by Design®, our bespoke surface protection, to evoke a sense of connection with nature, or add an extra level of luxury and a unique touch to your space.



Explore
Acrovyn Colours

c-sgroup.eu/2445

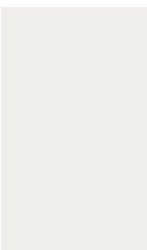
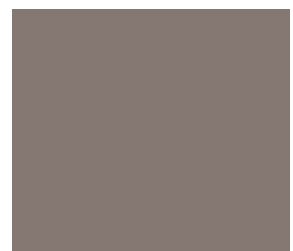
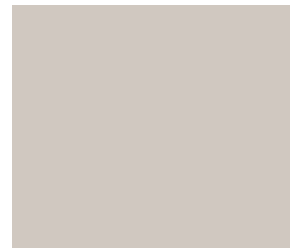

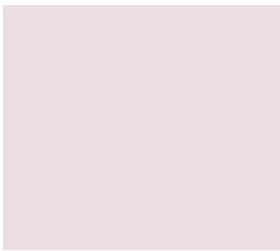
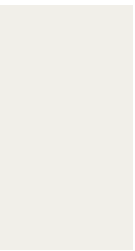
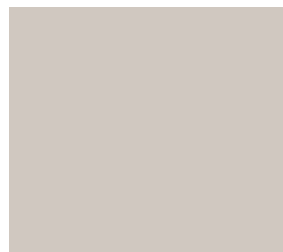
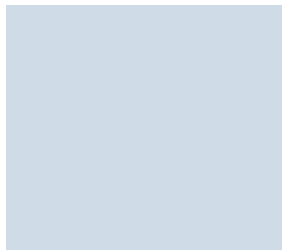
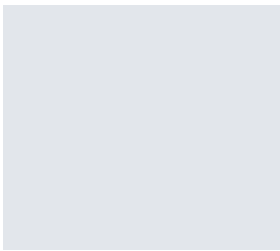

Customise *your protection.*

The days of functional wall protection are over. Acrovyn® gives you the freedom to realise your design vision with a range of flexible options. Now, you can create beautiful interiors that last.



MURALS AND CUSTOM SHAPES

Acrovyn Sheet is a versatile material that is easy to cut, shape and form, allowing you to create resilient and aesthetically pleasing environments. Imaginative, bright wall murals, durable signage and logos, or decorative door protection can be readily achieved.



BESPOKE IMAGERY AND GRAPHICS

When it comes to Acrovyn by Design, the possibilities are truly endless. Your graphics, photos, patterns or custom messaging will be safely embedded behind a durable layer of clear PVC-Free sheet, transforming your interiors into welcoming, healing, inspiring, energising or relaxing spaces that stand the test of time.



BESPOKE COLOURS

We understand the importance of colour in your design. If your desired shade isn't part of our extensive standard palette, we can manufacture bespoke colours to meet your needs ¹. Alternatively, Acrovyn by Design offers a solid colour printing option, harmonising with your wall finish or interior decor while keeping your spaces protected.



For inspiration and more information, visit:

c-sgroup.eu/17146

¹ Minimum order quantities apply. Please contact us to discuss your requirements.



The investment *of a lifetime.*

From gyms and universities to care homes and hospitals, any space that sees a lot of traffic should pay extra attention to its walls. Acrovyn® has been the trusted interior wall protection for more than 50 years. Why? Because it lasts.

Acrovyn's textures are expertly crafted to subtly veil scuffs and abrasions without compromising ease of cleaning. This perfect balance between texture and protection keeps your interiors looking beautiful for years. We bet you'll get tired of looking at it before it wears out.

CLEANABILITY

When it comes to hygiene, Acrovyn has been proven to be resistant to bacterial and fungal growth. Additionally, some of our solutions are enhanced with bactericidal additives uniformly distributed throughout the material, offering an extra level of protection.

Acrovyn's texture guards against dents and scratches where bacteria can hide. Plus, it can be cleaned easily with just soapy water or commonly used cleaning products, saving you time and money on maintenance and helping to reduce the risk of Hospital-Acquired Infections (HAIs).



View our
Cleaning Guidelines
here:

c-sgroup.eu/37968





**DOBIE HIGH SCHOOL
HOUSTON, US**
CORNER GUARDS
ACROVYN BY DESIGN

Protection, *perfected.*

Tried and tested in thousands of facilities worldwide, Acrovyn® offers you the best of both worlds: a customisable aesthetic with exceptional durability and performance capabilities. Our line of interior protection solutions is designed to ensure the longevity and flawless appearance of all types of buildings.

SHEET + WALL PANELS

Acrovyn Sheet
Acrovyn by Design
Acrovyn Wall Panels

Our durable wall finishes combine desired functionality with beautiful aesthetics. Take your pick from a palette of neutral and vivid solid colours, realistic woodgrain, metal or concrete finishes, or incorporate your graphics with Acrovyn by Design for that totally bespoke effect.

CORNER GUARDS

Acrovyn Corner Guards
Stainless Steel Corner Guards
EPDM Rubber Corner Guards

Preventing damage to wall corners and other structural protrusions is easy with our durable corner guards. Choose from a wide range of materials and finishes to find the protection that best suits your requirements and budget.

HANDRAILS

Acrovyn Handrails
Metal Handrails
Timber Handrails

Offering a comfortable grip and robust mobility support in corridors, our handrails are available in a range of materials and colour options to complement any design. Some models can be installed in continuous runs in staircases.

HAND / CRASH RAILS

Acrovyn Hand/Crash Rails

A range of products ideal for areas where impact damage is expected and pedestrian support is required. They are available in different styles and mounting options, including Quick Lock brackets and anti-ligature solutions.

CRASH RAILS

Acrovyn Crash Rails + Bumper Guards
Stainless Steel Crash Rails
EPDM Rubber Crash Rails

Designed to effectively protect the walls of corridors, waiting rooms and lobbies, our crash rails are offered in a variety of styles and duty ratings, from simple rub rails to EPDM rubber solutions that will stand up to severe impact.

BED HEAD PROTECTORS

Bed Head Protection Profiles
Flat Bed Head Protection

Used primarily in care settings, bed head protection solutions prevent impact damage to walls and wall mounted equipment or can be used to personalise spaces.

DOOR + FRAME PROTECTION

Door Protection
Door Frame Protection

Custom-made to protect faces, edges and/or frames of new or existing doors, our solutions are available in a wide selection of standard colours, decorative finishes and in bespoke designs with Acrovyn by Design®.





**PENN STATE HEALTH
HAMPDEN MEDICAL CENTER
PENNSYLVANIA, US**
ACROVYN PVC-FREE SHEET
CORNER GUARDS
CRASH RAILS

The finishing touch.

Mix and match any of our durable Acrovyn® wall protection products to create a look that is tailored to your space and specific needs.

1

2

4

- 1 Acrovyn Textured Sheet
- 2 Handrail
- 3 Crash Rail
- 4 Acrovyn by Design® Bespoke Wall Protection
- 5 Door Protection
- 6 Corner Guard

3





5

6

INTERIOR PRODUCTS

Acrovyn[®]
Wall Protection



Making and taking *an impact.*

Bring your dream space to life with our Sheet & Panel collection. More durable than painted finishes, wallpaper or laminate, Acrovyn® is designed to keep up with the toughest daily abuse whilst still being easy to maintain.



TEXTURED SHEET

Our impact resistant sheet can be used in a variety of spaces to ensure functionality, protection and pleasing decor. Choose from a wide range of colours in PVC or PVC-Free, or select our decorative finishes to create a welcoming and long-lasting interior.



ACROVYN BACTERICIDE

Developed to help combat the threat of hospital acquired infections (HAIs), our Acrovyn Bactericide Sheet is proven to kill bacteria on contact. Available in 2mm thick textured and smooth variants, it will remain effective throughout its long lifespan.



SMOOTH SHEET

In sterile environments, an easy to clean and durable surface finish is essential. An alternative to tiles, our Acrovyn Smooth Sheet won't crack under impact and is suitable for steam cleaning.



ACROVYN BY DESIGN®

Patterns, logos, photographs—any unique visual statement that you imagine, we can embed. Acrovyn by Design is loved by architects, interior designers, and owners for its ability to create stunning interiors without the worry of damage.



WALL PANELS

Designed for the protection of walls in high-traffic areas, Acrovyn Wall Panels comprise our impact resistant Acrovyn Sheet adhered to a rigid MDF board.

Where high fire resistance is vital, Acrovyn FP Panels offer a durable finish to A1 or A2-s1, d0 rated substrates.





**CALVARY ADELAIDE HOSPITAL
AUSTRALIA**
ACROVYN BY DESIGN
ACROVYN SHEET
HANDRAILS

Compare Rigid Sheet Options

Available in a range of materials, textures and finishes to deliver the required aesthetic and functionality to your interior spaces. Protect both your walls and your budgets with Acrovyn®.



For more information and to download Product Sheets, visit:

c-sgroup.eu/413



Material	PVC			PVC with Bactericide ¹
Product Name	Acrovyn Textured Sheet	Acrovyn Smooth Sheet	Acrovyn Decorative Finishes	Acrovyn Bactericide
Standard Colours	36 solid colours	10 solid colours	6 woodgrains 3 concretes, 3 metals	Textured 6 colours, smooth 1 colour
Texture	Suede	Smooth	Suede	Suede or Smooth
Thickness	2 mm	2 mm	2 mm	2mm
Maximum Size	3000 x 1300 mm	3000 x 1300 mm	3000 x 1250 mm	3000 x 1300 mm
Fire Rating	B-s2, d0 ²	B-s2, d0 ²	M1 ³	B-s2, d0 ²
Environmental Certifications	EPD	EPD	-	-

¹ Incorporates an anti-microbial additive, Sanitised® zinc pyrithione, which will remain effective throughout the product's lifecycle. Tested to ISO 22196 and classified according to EN 1040. Sanitised® is a registered trademark of Sanitized AG. For further details and test results refer to Product Sheet.

² Fire rating class, classified according to EN 13501-1, under conditions laid down in the relevant test reports, which are available on request.

³ Fire rating class, classified according to NF P 92-512:1986, test report available on request.



PVC-Free		Stainless Steel (304L)
		
Acrovyn PVC-Free Textured Sheet	Acrovyn by Design	Acrovyn Stainless Steel Sheet
36 solid colours	Bespoke imagery, graphics or colours	Silver-grey
Suede	Suede	Brushed
1.5 or 1 mm	1 mm	1 mm
3000 x 1300 mm	3000 x 1270 mm; large murals consist of multiple sheets	2500 x 1250 mm
B-s1, d0 ²	-	Considered class A1 (non-combustible)
EPD Cradle to Cradle Certified® Bronze	-	-



ACROVYN WALL PROTECTION - PANELS



Material	PVC or PVC-Free Sheet on MDF Board	Gypsum-Fibre Board with Textured Acrylic Coating
		
Product Name	Acrovyn Wall Panels	Acrovyn FP Panels
Panel Finish	2 mm PVC sheet (textured or smooth) or 1.5 mm PVC-free sheet (textured)	Acrylic coating
Texture	Suede texture or smooth	Light texture
Colours	Solid colours: 36 (textured) + 10 (smooth)	Matched to Acrovyn colours + RAL colours
Overall Thickness	11 mm (inc. 9 mm thick MDF as standard)	12.5 mm
Maximum Size	2400 x 1200 mm	1250 x up to 1250 mm (part height applications) 1250 x up to 2530 mm (full height applications)
Edges	Unfinished (trims available), wrapped on 2 edges or wrapped on 4 edges	Unfinished (trims available)
Fire Rating	Standard MDF board is non-rated; MDF tested to EN 13501 can be supplied if required	A2-s1, d0 ¹

¹ Fire rating class, classified according to EN 13501-1. Panels must be installed to a substrate of reaction to fire class A1 or A2-s1, d0 using A2 rated adhesive. Test reports available on request.

Compare Wall Panels

Our rigid wall panels are designed for permanent installation in high-traffic areas such as corridors and lifts, where damage often occurs.

Where stringent fire rating requirements exist, specify Acrovyn® FP Panels for a durable finish.



For more information and to download Product Sheets, visit:

c-sgroup.eu/413



ACROVYN FP PANELS INSTALLED
WITH STAINLESS STEEL TRIMS

Complement *your corners.*

External wall corners and other structural protrusions often bear the brunt of daily wear and tear, compromising the appearance, cleanliness, and safety of your interiors. Our robust and easy-to-maintain products not only preserve these corners, but also enhance hygiene and significantly cut down on maintenance expenses.



ACROVYN CORNER GUARDS

From 75 mm wide leg models backed with aluminium retainers, to discreet, 30 mm wide and simple-to-install stick-on options, we've got corner guards to suit your level of protection requirements, corner angle and interior decor.

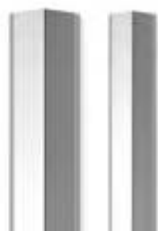

STAINLESS STEEL CORNER GUARDS

Complementing our offering of stainless steel crash rails and handrails, these corner guards are ideal for hygiene-sensitive areas in commercial environments or kitchens.



EPDM RUBBER CORNER GUARDS

Boasting excellent shock-absorbing and weather-resistant qualities, our EPDM Rubber guards are a perfect fit for back-of-house and delivery areas or car parks. Complementary crash rails are available.



**PRIMARY SCHOOL
CZECH REPUBLIC**
ACROVYN SHEET
CORNER GUARDS



DURABLE, FLEXIBLE AND REPLACEABLE

Our heavy duty Acrovyn Corner Guards feature a continuous aluminium retainer for extra strength and durability. The replaceable, snap-on cover flexes upon impact and recovers to its original shape, while the textured finish minimises the appearance of scratches and abrasions.

Compare Corner Guards

Browse through a range of materials, sizes and colours to find a solution that will protect your interior in style.



For more information and to download Product Sheets, visit:



c-sgroup.eu/396



Material	PVC				PVC-Free	
Product Name	SM-20	SSM-20	SM-20M	S0 Series	SM-20N	SSM-20N
Leg Size	76 mm	51 mm	76 mm	30, 50 or 75 mm	76 mm	51 mm
Angle	90°	90°	135°	90° - all sizes, 80 - 175° (50 mm)	90°	90°
Duty Rating	Heavy	Heavy	Heavy	Medium	Heavy	Heavy
Texture / Finish	Shadowgrain	Shadowgrain	Shadowgrain	Shadowgrain	Shadowgrain	Shadowgrain
Colours	27 solid colours	27 solid colours 12 finishes	27 solid colours	36 solid colours 12 finishes (50 mm)	15 solid colours	15 solid colours
Fixing Method	Mechanical Fixing	Mechanical fixing	Mechanical fixing	Foam tape or adhesive	Mechanical fixing	Mechanical fixing



Ambulatory Treatment Unit
 Intensive Care Unit
 Intensive Care Waiting

PVC-Free	Stainless Steel (304L)	EPDM Rubber
		
TF-N	A Series	C Series
To order (min. 30, max. 645 mm)	30, 50 or 75 mm	75 or 100 mm
90°	90° as standard	90°
Medium	Heavy	Severe
Suede	Brushed	Smooth
36 solid colours	Silver-grey	Black
Foam tape or adhesive	Adhesive or mechanical fixing	Mechanical fixing and/or adhesive

SPECIFICATION GUIDANCE

Corner guards can be installed to cover either the full or partial height of the wall, depending on where the impact damage is likely to occur. Most of our models are available in stock lengths of 3 m, or can be supplied pre-cut to required size.

Acrovyn models starting with designations SM- and SSM- feature free-floating covers over a continuous aluminium retainer, and are supplied complete with top and bottom end caps. Covers are easily replaceable in case of damage.

The choice of corner guard colour can help with achieving an inclusive design, as colours that contrast with the wall will help visually impaired users identify obstructions and corners.

For LRV values of all our colours, visit:

[c-sgroup.eu/2445](https://www.c-sgroup.eu/2445)

Mobility *with style.*

No matter the type of facility, our line of handrails is designed to help your building's occupants stay mobile. With a wide choice of material options, colours and finishes on offer, our handrails will complement interior design schemes whilst meeting legislative and functional requirements.



ACROVYN HANDRAILS

Handrails featuring Acrovyn covers are durable and easy to clean. Choose from circular or oval-shaped options, in a wide spectrum of colours or decorative finishes to meet visual contrast requirements.



TIMBER HANDRAILS

Our solid timber models with stainless steel accessories will add warmth and style to any interior. All of our timber comes from sustainable sources and carries FSC or PEFC certification.



METAL HANDRAILS

Whether you are after the sleek look of stainless steel or a more economical, but still durable, aluminium handrail, we've got options to suit.



ADAPTOR FOR STAIRCASE INSTALLATIONS

Designed to rotate around two axes to adjust to any required angle, our adaptor facilitates continuous handrail installation in staircases.

Available in 27 solid colours, it is compatible with HREB-6, HRE-6 and HRA-6 handrail models.





**LAPWING COURT RETIREMENT
HOME, PETERBOROUGH, UK**
TIMBER HANDRAILS

Compare Handrails

From Acrovyn® Bactericide to Stainless Steel Handrails, with our wide range you can choose from options that suit the function and aesthetics of your interior. All our circular models can be installed to curved walls if required, with select models also suitable for continuous installation in staircases.



For more information and to download Product Sheets, visit:

c-sgroup.eu/372





Material	PVC with Bactericide ¹	PVC		PVC-Free	
Product Name	HREB-6 Series	HRE-6 Series	HRO-6 Series	HR-6N Series	HRO-6N Series
Mounting Options	Aluminium or stainless steel brackets	Aluminium or stainless steel brackets	Aluminium or stainless steel brackets	Stainless steel brackets	Aluminium or stainless steel brackets
Shape	Circular, 40 mm ø	Circular, 40 mm ø	Oval, 38 mm wide	Circular, 40 mm ø	Oval, 38 mm wide
Wall Stand-off (Bracket Dependent)	90 or 102 mm	90 or 102 mm	75 or 88 mm	89 or 101 mm	75 or 88 mm
Texture or Finish	Smooth	Smooth	Shadowgrain	Shadowgrain	Shadowgrain
Colours	27 solid colours	12 finishes	27 solid colours 12 finishes	15 solid colours	15 solid colours

¹ Incorporates an anti-microbial additive, Sanitised® zinc pyrithione, which will remain effective throughout the product's lifecycle. Tested to ISO 22196 and classified according to EN 1040. Sanitised® is a registered trademark of Sanitized AG. For further details and test results refer to Product Sheet.

² All our timber comes from sustainable sources and carries FSC or PEFC certification.



Timber	Stainless Steel (304L)	Aluminium
		
HRW-6 Series	HRS-6 Series	HRA-6 Series
Stainless steel brackets	Stainless steel brackets	Aluminium or stainless steel brackets
Circular, 40 mm ø	Circular, 40 mm ø	Circular, 40 mm ø
78 or 101 mm	89 or 101 mm	90 or 102 mm
Supplied untreated or lacquered	Brushed finish	Clear anodised finish
Oak, Beech or Maple ²	Silver-grey	Silvery-white



ACROVYN WALL PROTECTION - HAND / CRASH RAILS



**FRANCISCA CEREJA CARE HOME
SANTAREM, PORTUGAL**

HAND/CRASH RAILS
HANDRAILS
RUB RAILS
CORNER PROTECTION



Where function meets design.

Our robust line of hand/crash rails is designed to meet your interior protection needs while offering pedestrian support in circulation areas. Available in a choice of styles, sizes and configurations to suit your requirements.



HAND/CRASH RAILS

Elegant and ergonomically designed, our products provide impact protection and comfortable pedestrian support. Available for installation on Quick Lock or on optional anti-ligature brackets.



COMBINED HAND/CRASH RAILS

Exhibiting both style and strength, our combined hand/crash rails are fitted on robust stainless steel brackets, offering both code compliance and reliable protection.



MAKE IT EASY WITH QUICK LOCK

Our innovative Quick Lock design eliminates the need for drilling holes in the retainer. As well as easy installation, it offers effortless and convenient removal with a mere half-turn twist at the bracket.

See how easy it is.



c-sgroup.eu/3055







Compare Hand/Crash Rails

Choose from Quick Lock™ mounted models for easy installation, or continuous bracket options where there is a risk of ligatures.





For more information and to download Product Sheets, visit:

c-sgroup.eu/133

Material	PVC			PVC-Free		
						
Product Name	HRB-20 Series	HRB-4C Series	HRB-35 Series	HRB-20N Series	HRB-4CN Series	HRB-35N Series
Mounting Options	Quick Lock or anti-ligature brackets	Quick Lock or anti-ligature brackets	Quick Lock brackets	Quick Lock or anti-ligature brackets	Quick Lock or anti-ligature brackets	Quick Lock brackets
Height	143 mm	140 mm	89 mm	143 mm	140 mm	89 mm
Wall Stand-off	76 mm	76 mm	76 mm	76 mm	76 mm	76 mm
Grip	Oval	Rounded	Rounded	Oval	Rounded	Rounded
Duty Rating	Heavy	Severe	Heavy	Heavy	Severe	Heavy
Colours	27 solid colours; 12 finishes (top only); dual colour available	27 solid colours	27 solid colours	15 solid colours; dual colour available	15 solid colours	15 solid colours



PVC-Free	Timber/ PVC-Free
	
HRB-50N	HRBW-50N
Stainless steel brackets	Stainless steel brackets
220 mm	220 mm
101 mm (handrail) 120 mm (crash rail)	101 mm (handrail) 120 mm (crash rail)
Rounded 40 mm ø	Rounded 40 mm ø
Heavy	Heavy
15 solid colours, mixed or matched	3 timber species ¹ (top); 15 solid colours (bottom)



¹ All our timber comes from sustainable sources and carries FSC or PEFC certification

Flawless protection *for every condition.*

Our crash rails (also called bumper rails or guards) offer 24-7 protection where you need it most. Choose from a wide range of options to keep walls in your corridors, lobbies, waiting rooms and service areas in perfect condition.



ACROVYN CRASH RAILS

Acrovyn crash rails come in a wide spectrum of shapes, sizes, material and colour/finish options to suit your aesthetic and functional protection requirements.



STAINLESS STEEL CRASH RAILS

Offering a sleek and smooth appearance, stainless steel models are ideal for hotel, commercial and retail environments. The range includes a floor mounted product used to protect glazed corridors and other building features.



EPDM RUBBER CRASH RAILS

These robust products, with excellent shock-absorbing and weather-resistant qualities, are perfect for protecting back-of-house, delivery areas, warehouses or car parks from damage caused by vehicular traffic, trolleys and carts.



**NORTH MANCHESTER HOSPITAL
UK**
CRASH RAILS
CORNER GUARDS
DOOR PROTECTION



CREATED FOR IMPACT AND RECOVERY

Carts and heavy foot traffic are no match for our Acrovyn crash rails. Their durable covers flex under impact and recover to original shape, whilst aluminium retainers, equipped with bumper cushions, absorb the impact energy and dissipate it along the crash rail's length.



Compare Crash Rails

From simple rub rails to severe duty crash rails mounted on Quick Lock™ brackets, our range is designed to meet your protection needs in style.

For EPDM Rubber and Stainless Steel models, see pages 46-47.



For more information and to download Product Sheets, visit:





c-sgroup.eu/608

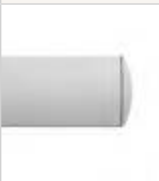

Material	PVC							
Product Name	SCR-80 Series	SCR-50 Series	SCR-170 Series	SCR-200 Series	HCR-200	BG-10	FR-225	TP Series
Height	203 mm	127 mm	170 mm	203 mm	203 mm	102 mm	57 mm	100, 150, 200 or 300 mm
Wall Stand-off	35 mm	27 mm	35 mm	32 mm	83 mm (inc. Quick Lock)	60 mm	19 mm	3 mm
Profile Shape	Curved	Curved	Curved	Flat	Flat	Bullnose	Flat	Flat
Duty Rating	Heavy or medium ¹	Heavy or medium ¹	Heavy or medium ¹	Heavy or medium ¹	Severe	Medium	Light	Medium
Texture	Shadowgrain	Shadowgrain	Smooth (cover), Suede (insert)	Shadowgrain	Shadowgrain	Shadowgrain	Shadowgrain	Shadowgrain
Colours	27 solid colours 12 finishes	27 solid colours	27 solid colours, optional inserts 36	27 solid colours	27 solid colours	27 solid colours	27 solid colours	36 solid colours

¹ Duty rating dependent on the type of mounting selected.



PVC-Free				
				
SCR-80N Series	SCR-50N Series	SCR-150N Series	BG-10N	FR-225N
203 mm	127 mm	152 mm	102 mm	57 mm
35 mm	27 mm	32 mm	60 mm	19 mm
Curved	Curved	Flat	Bullnose	Curved
Heavy or medium ¹	Heavy or medium ¹	Heavy or medium ¹	Medium	Light
Shadowgrain	Shadowgrain	Shadowgrain	Shadowgrain	Shadowgrain
15 solid colours	15 solid colours	15 solid colours	15 solid colours	15 solid colours

SPECIFICATION GUIDANCE







To ensure the right level of protection, the type and location of crash rails should be determined in relation to frequency and severity of impact, as well as the anticipated damage position.

Some of our models are available in a choice of duty ratings. Variants featuring continuous aluminium retainers are rated for Heavy Duty, whilst those mounted on aluminium clips offer Medium Duty protection.

Models with Acrovyn or Acrovyn PVC-Free covers are typically selected for general circulation areas. For other material options, refer to pages 46-47.

ACROVYN WALL PROTECTION - CRASH RAILS

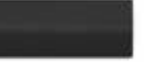

Material	Stainless Steel (Grade 304L)				EPDM Rubber			
								
Product Name	CRC-150	CRS Series	LLRSS	PP-76	200W Series	150W20	D-Section Series	60B
Height	150 mm	100, 150 or 200 mm	178 mm (floor mounted)	900 mm as standard	200 mm	150 mm	75 or 100 mm	60 mm
Wall Stand-off	36 mm	32 mm	140 mm	N/A	30 or 50 mm	20 mm	68 or 90 mm	30 mm
Profile Shape	Curved	Flat	51 mm ø rail	76 mm ø post 200 mm ø base	Flat	Curved	D-shaped	B-shaped
Duty Rating	Heavy	Heavy	Severe	Severe	Severe	Severe	Severe	Heavy
Colour or Finish	Silver-grey, brushed finish	Silver-grey, brushed finish	Silver-grey, brushed finish	Silver-grey, brushed finish	Black; light reflective tapes available	Black	Black	Black



Compare Crash Rails

Some materials are well-suited to certain environments, such as stainless steel in kitchens and laboratories, or robust EPDM Rubber in delivery areas and car parks. Complementary Corner Guards are available for a seamless, integrated look.



For more information and to download Product Sheets, visit:

c-sgroup.eu/608



Preserving *patient spaces.*

Typically used in healthcare facilities where patient beds are frequently moved around or adjusted, Acrovyn® Bed Head Protectors are designed to keep walls or wall mounted equipment free from damage.



HORIZONTAL BED HEAD PROTECTORS

Designed for areas where beds are frequently moved around, our protectors can be mounted on spacers or on custom length brackets to keep wall mounted equipment damage free.



VERTICAL BED HEAD PROTECTOR PAIRS

Vertically mounted models are ideal for applications where bed heights are frequently adjusted. They are available in a range of styles and mounting options.



FLAT BED HEAD PROTECTION

Acrovyn Sheet or Acrovyn by Design afford a bespoke, decorative and easy to maintain beadhead wall finish, which can be combined with our other options.

ROYAL ORTHOPAEDIC
HOSPITAL, LONDON, UK
BED HEAD PROTECTORS
ACROVYN BY DESIGN



PERSONALISED IMPACT PROTECTION







Vertical bed head protection profiles absorb impact and keep beds away from the wall, allowing for bed height adjustment to suit patient needs.

Acrovyn Sheet or bespoke Acrovyn by Design provide an attractive, long-lasting and wipe clean wall finish.



ACROVYN WALL PROTECTION - BED HEAD PROTECTION



Material	PVC			PVC with Bactericide ¹	PVC-Free		
							
Product Name	BL-10H Series	BL-10V Series	BL-4C Series	BL-40V Series	BL-10HN Series	BL-10VN Series	BL-4CN Series
Mounting Options	Spacers or extended brackets	Spacers or extended brackets	Quick Lock or extended brackets	Stainless steel brackets	Spacers or extended brackets	Spacers or extended brackets	Quick Lock or extended brackets
Size (inc. End Caps)	1100 mm width (1600 mm max)	700 mm height	700 mm height	700 mm height	1100 mm width (1600 mm max)	700 mm height	700 mm height
Wall Stand-off	60 or 347 mm	60 or 347 mm	76 or 338 mm	104 mm	60 or 347 mm	60 or 338 mm	76 mm
Profile Shape	Bullnose	Bullnose	Flat	Circular	Bullnose	Bullnose	Flat
Duty Rating	Medium	Medium	Severe	Medium	Medium	Medium	Severe
Texture	Shadowgrain	Shadowgrain	Shadowgrain	Smooth	Shadowgrain	Shadowgrain	Shadowgrain
Colours	27 solid colours	27 solid colours	27 solid colours	27 solid colours	15 solid colours	15 solid colours	15 solid colours

¹ Incorporates an anti-microbial additive, Sanitised® zinc pyrithione, which will remain effective throughout the product's lifecycle. Tested to ISO 22196 and classified according to EN 1040. Sanitised® is a registered trademark of Sanitized AG. For further details and test results refer to Product Sheet.



Compare Bed Head Protection

Our selection of durable profiles and wall finishes caters for a variety of situations and bed head protection needs.



For more information and to download Product Sheets, visit:

c-sgroup.eu/2564

FLAT BED HEAD PROTECTION

For a solution that complements your interior decor, select from durable Acrovyn Sheet variants, or incorporate your artwork into Acrovyn by Design to personalise and enhance your spaces.

All options can be specified as standalone or in combination with any of our bed head protection profiles.

See pages 26-27 for more detail.



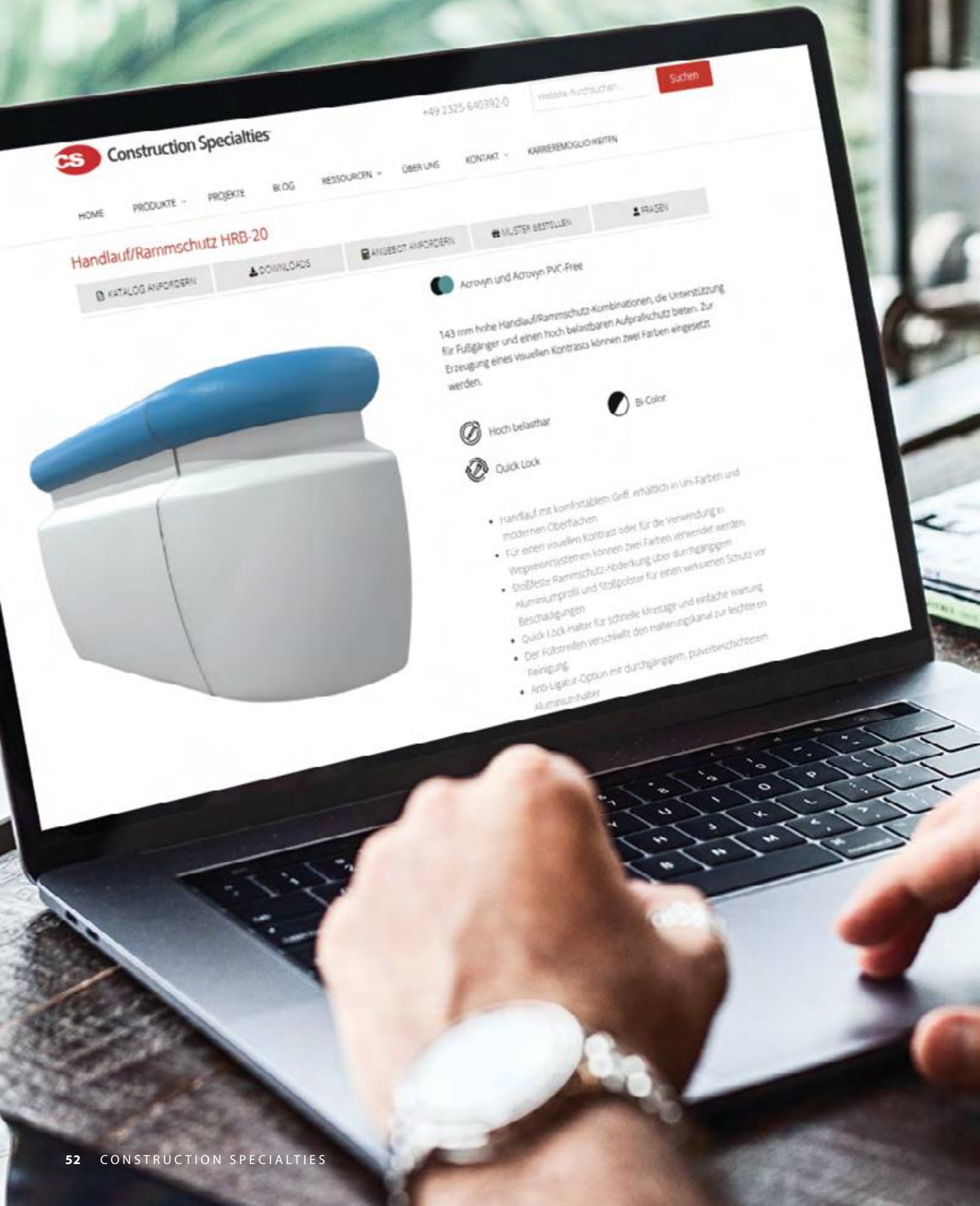

Handlauf/Rammschutz HRB-20

KATALOG ANFORDERN **DOWNLOADS** **ANGEBOT ANFORDERN** **MUSTER BESTELLEN** **FRAGEN**



Acrovyn und Acrovyn PVC-Free
143 mm hohe Handlauf/Rammschutz-Kombinationen, die Unterstützung für Fußgänger und einen hoch belastbaren Aufprallschutz bieten. Zur Erzeugung eines visuellen Kontrasts können zwei Farben eingesetzt werden.

- Hoch belastbar
- Quick Lock
- Bi-Color

- Handlauf mit komfortablem Griff, erhältlich in Uni-Farben und modernen Oberflächen
- Für einen visuellen Kontrast oder für die Verwendung in Wegweisungssystemen können zwei Farben verwendet werden
- Stößelste Rammschutz-Abdeckung über durchgängigem Aluminiumprofil und Stößelpolster für einen wirksamen Schutz vor Beschädigungen
- Quick Lock-Halter für schnelle Montage und einfache Wartung
- Der Fußstreifen verschleift den Nahrungskanal zur leichteren Reinigung
- Anti-Ligatur-Option mit durchgängigem, pulverbeschichtetem Aluminiumhalter



Need more *information?*

Browse our website to identify the best solution for your project. Find inspiration, compare products, dimensions, performance, and more – all in one place. Not sure? Contact us for assistance.

Explore wall protection options.

c-sgroup.eu/29



View a complete set of Product Sheets.

c-sgroup.eu/ps-iwp-eu



INTERIOR PRODUCTS

Acrovyn[®]
Door Protection



Protect *doors and budgets.*

Doors and door frames are vulnerable to damage, and will often require periodic maintenance or replacement throughout the life of the building. Wood veneer or high pressure laminate just can't handle the same wear and tear as durable Acrovyn®, which has been protecting doors in thousands of facilities worldwide.



KEY BENEFITS OF DOOR PROTECTION

Hygiene - prevents dents, cracks and scratches, which are an ideal breeding ground for bacteria

Maintenance - eliminates or reduces the need for premature replacement or repair, protecting budgets

Appearance - prevents deterioration of door surfaces over its life cycle





**PROSPECT PARK HOSPITAL
DEMENTIA WARD
READING, UK**
DOOR FACE PROTECTION WITH
ACROVYN BY DESIGN

Doors *with an edge.*

Cracks and chips often happen at the door edge. Our Door Edge Protectors (DEPs) have been designed to withstand impacts and prolong the lifespan of timber core doors. If maintenance is needed, simply replace the edge – an easier and cost-effective alternative to replacing the door, with minimal downtime.

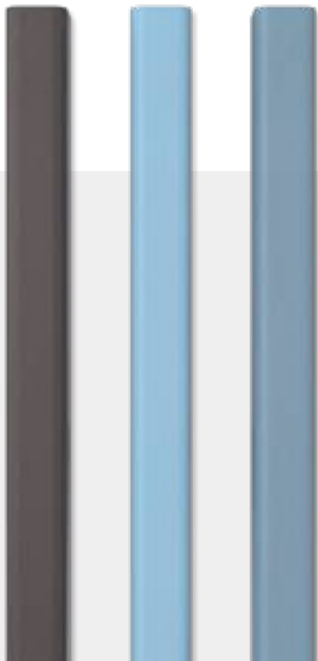

ROBUST AND SAFE

Our DEPs can be applied to one or both edges of new or existing timber core doors, and can be used in combination with door face protection options if required.

Manufactured in sizes to suit 44 to 54 mm doors as standard, they are available in 36 colourways.





Tailored *to your needs.*

We know that no two projects are the same. With our flexible solutions, you can easily equip your doors with the right level of protection to ensure a long service life.



DOOR CLADDING

Manufactured to custom sizes, door cladding protects door faces and vertical edges. Configured from plates and channels or formed angles, it can be applied to the full or partial height of the door.



DOOR FACE PROTECTION

Whether you wish to protect small areas of the door or its full face from damage, Acrovyn presents a simple and economical solution. Available in a wide range of standard designs or incorporating custom imagery or shapes.



DOOR EDGE PROTECTORS (DEPs)

Protect the edges of new or existing timber core doors with our robust DEPs. They can be applied to one or both door edges and are designed to be easily replaced in case of damage.



DOOR FRAME PROTECTION

It is not just the doors that take a beating. Door frames and architraves can easily get damaged by mobile equipment being moved around.

Our Door Frame Protection is made to order and built up from a series of channel and angle sections to wrap around different styles of timber and metal door frames.

Compare Door Protection Options

When applied to doors, Acrovyn® Sheet delivers a sturdy and easy-to-clean surface finish. It offers flexible configuration options to optimally safeguard your doors against wear and tear.



For more information and to download Product Sheets, visit:

c-sgroup.eu/16726



Material	PVC			
Product Name	Door Cladding	Door Face Protection	Door Edge Protectors	Door Frame Protection
Door Protection Thickness	2 mm	2 mm	50 mm leg size, width to suit 44 to 54 mm thick doors	2 mm
Protected Areas	Door faces & edges	Door faces	Door edges	Door frames & architraves
Size	Full or partial door height	Full or partial door height	Full height (standard 2100 mm, max 2500 mm)	Full or partial height
Shape	Square cut plates & channels, or angles	Rectangular, 10 decorative designs + custom designs	Channel with infill strip	Combination of channels & angles
Colours	36 solid colours 12 finishes	36 solid colours 12 finishes	36 solid colours	36 solid colours 12 finishes



PVC-Free		
		
Door Cladding	Door Face Protection	Door Frame Protection
1.5 mm	1.5 mm (solid colours) 1 mm (Acrovyn by Design)	1.5 mm
Door faces & edges	Door faces	Door frames & architraves
Full or partial door height	Full or partial door height	Full or partial height
Square Cut Plates & Channels, or Angles	Rectangular, 10 Decorative Designs + Custom Designs	Combination of channels & angles
36 solid colours	36 solid colours or custom colours/graphics (AbD)	36 solid colours



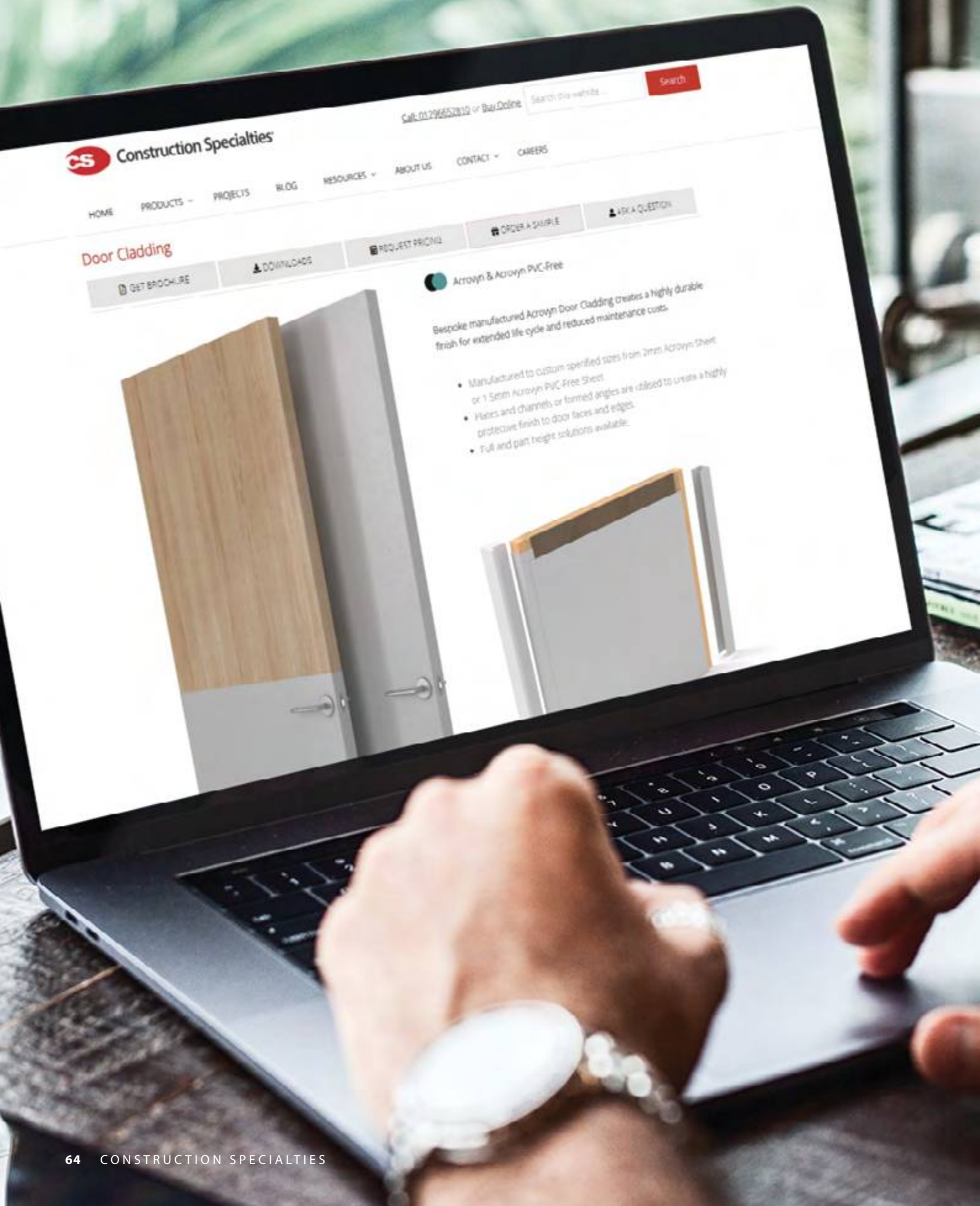



Need more *information?*

Browse our website to identify the best solution for your project. Look for inspiration, compare products, dimensions, performance, and more – all in one place. Not sure? Contact us for assistance.

Explore door
protection options:

c-sgroup.eu/16726



View a complete set
of Product Sheets.

c-sgroup.eu/ps-iwp-eu



PRODUCT SHEETS

Acrovyn[®]
Wall & Door Protection







Let's get into *the details.*

Within this document you will find detailed product sheets for each of the models in our Wall & Door Protection range as well as comparison tables to help identify the right solution for your application.

If you can't find what you're looking for, or would like to discuss your project with us, please get in touch:

E: information@c-sgroup.com T: +33 (0)2 32 67 00 00

Acrovyn[®]
Rigid Sheet



Acrovyn® Textured Sheet - Solid Colours



Designed to protect and enhance building interiors subjected to daily abuse, our impact resistant Acrovyn Sheet is offered in a variety of beautiful colours and has a light texture, making it easy to maintain to a high standard. It can be used on a range of substrates at full or partial height, providing long-lasting protection to surfaces it is adhered to.



CE Marked



B-s2, d0



Class A+

Features & Advantages

- Durable Acrovyn keeps interiors protected and looking good
- Wide range of colours allows for coordination within any interior design scheme
- Through-coloured and textured to conceal scratches and abrasions
- Easy to cut, form and apply to a variety of substrates
- Easy to clean and maintain

Applications

- High-traffic and high-impact areas
- Corridors
- Classrooms
- Entrances and waiting areas
- Wards and patient rooms
- Back of house

Colours & Texture

Solid Colours
36Texture
Suede

See reverse for details.



c-sgroup.eu/414

Acrovyn® Textured Sheet - Solid Colours

Product Details

- 2 mm thick: 3000 x 1300 mm
Custom sizes within standard dimensions available
- Suede texture
- Can be thermoformed for inside and outside corners
- Straight-cut edge is standard, 45° or round bevel available on request
- Creative designs, signage and logos can be supplied
- Installed with adhesive for permanent fix

Certifications & Testing

- Fire rating class **B-s2, d0**, classified according to EN 13501-1 under conditions as laid down in the relevant test reports, which are available on request.
- Gross Heat of Combustion (calorific value) - 17,818 MJ/kg (tested to EN ISO 1716)
- Does not propagate the growth of bacteria or fungi on a clean surface (tested to EN ISO 846:1997)
- Impact resistant (tested to EN ISO 6603-1:2000)
- Abrasion resistant (tested to ASTM D 4060)
- Chemically resistant (contact us for further details)
- VOC emissions class A+ (tested to ISO 16000 principles)
- Environmental Product Declaration (EPD) no. S-P-02036 (independent assessment according to ISO 14025)

Finishing Accessories

Where temperature fluctuations are expected, small gaps should be left at installation edges, in joint positions and around cutouts to allow the material to expand and contract. The following finishing options are available:

Joint sealing:



Mastic [IACC-SC]
All colours, 310 ml tubes



Welding Rod [AE-1127]
All colours, 100 m rolls

Trims:
(3 m lengths)



Acrovyn Vertical Trim [AE-0548 / AE-1085]
All colours (Front)

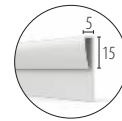

Acrovyn Edge Trim [AE-0958]
All colours

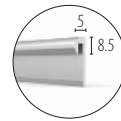

Aluminium Edge Trim [AE-1161]
Natural anodised

Cleaning & Maintenance

- Can be cleaned using soapy water, commonly used disinfectants or domestic cleaning products.
- Can be steam cleaned with suitable attachments, such as mops (150°C hot steam at max 5 bar pressure setting).

For Cleaning Guidelines visit: c-sgroup.eu/37968

Warranty & Lifespan

- 2-year product warranty
- Up to 25-year life expectancy

For Terms and Conditions visit: c-sgroup.eu/16727

Colour Selector

LRV (Light Reflectance Value) indicates the amount of light reflected by a surface and can be used to assess the degree of visual contrast between different surfaces. LRV values for Acrovyn colours have been determined using the CIE Y value measurement method.

Acrovyn® Smooth Sheet



Easy to clean, Acrovyn Smooth Sheet provides a durable surface finish in sterile environments. An alternative to tiles, it won't crack under impact and become a breeding ground for bacteria. It is also suitable for steam cleaning to suit stringent cleaning regimes.



CE Marked



B-s2, d0



Class A+

Features & Advantages

- Durable, smooth and impervious surface
- Easy to clean and maintain to a high standard, conforms to food hygiene requirements
- Suitable for hot steam cleaning
- Available in a range of pastel shades to coordinate with different design schemes
- Resistant to most stains and chemicals
- Easy to cut, form and apply to a variety of substrates

Applications

- Laboratories
- Kitchens
- Food serving and dining areas
- Food manufacturing
- An alternative to wall tiles

Colours & Texture

Solid Colours
10Texture
Smooth

See reverse for details.



c-sgroup.eu/415

Acrovyn® Smooth Sheet

Product Details

- 2 mm thick: 3000 x 1300 mm
Custom sizes within standard dimensions available
- Smooth finish
The sheet is supplied with a protective film to the face side, which should be removed after installation, once the area is ready to use.
- Can be thermoformed for inside and outside corners
- Straight-cut edge is standard, 45° or round bevel available on request
- Installed with adhesive for permanent fix

Certifications & Testing

- Fire rating class **B-s2, d0**, classified according to 13501-1, under conditions laid down in the relevant test reports, which are available on request.
- Gross Heat of Combustion (calorific value) - 17,818 MJ/kg (tested to EN ISO 1716)
- Does not propagate the growth of bacteria or fungi on a clean surface (tested to EN ISO 846:1997)
- Impact resistant (tested to EN ISO 6603-1:2000)
- Abrasion resistant (tested to ASTM D 4060)
- Chemically resistant (contact us for further details)
- VOC emissions class A+ (tested to ISO 16000 principles)
- Environmental Product Declaration (EPD) no. S-P-02036 (independent assessment according to ISO 14025)

Finishing Accessories

Where temperature fluctuations are expected, small gaps should be left at installation edges, in joint positions and around cutouts to allow the material to expand and contract. The following finishing options are available:

Joint sealing:



Mastic [IACC-SC]
All colours, 310 ml tubes



Welding Rod [AE-1127]
All colours, 100 m rolls

Trims:
(3 m lengths)



Acrovyn Vertical Trim [AE-0548 / AE-1085]
All colours (Front)

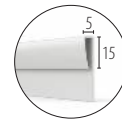

Acrovyn Edge Trim [AE-0958]
All colours

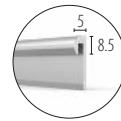

Aluminium Edge Trim [AE-1161]
Natural anodised

Cleaning & Maintenance

- Can be cleaned using soapy water, commonly used disinfectants or domestic cleaning products.
- Can be steam cleaned with suitable attachments, such as mops (150°C hot steam at max 5 bar pressure setting).

For Cleaning Guidelines visit: c-sgroup.eu/37968

Warranty & Lifespan

- 2-year product warranty
- Up to 25-year life expectancy

For Terms and Conditions visit: c-sgroup.eu/16727

Colour Selector

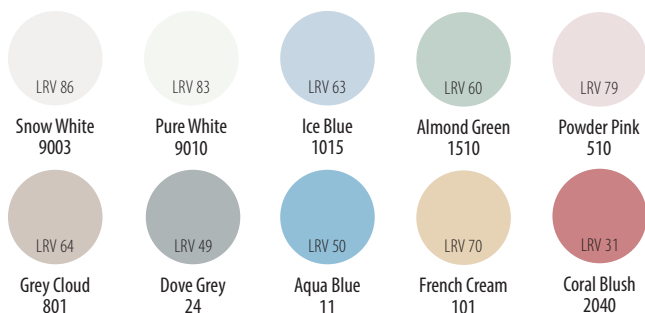

Other colours from our Acrovyn range can be supplied, subject to minimum order quantity.

LRV (Light Reflectance Value) indicates the amount of light reflected by a surface and can be used to assess the degree of visual contrast between different surfaces. LRV values for Acrovyn colours have been determined using the CIE Y value measurement method.

Acrovyn® Textured Sheet - Decorative Finishes



Create a distinctive aesthetic in your interior with our range of woodgrain, metallic and concrete finishes. Combining the warmth and contemporary looks with durability and ease of maintenance of Acrovyn, they are ideal for spaces looking for both design and function.



Class M1



Class A+

Features & Advantages

- Durable and impact resistant Acrovyn keeps interiors protected and looking good
- Patterned film is thermally bonded to Acrovyn Sheet during extrusion, resulting in a durable finish which won't wear off or delaminate
- Lightly textured surface offers additional resistance to scratches and abrasions
- Easy to cut, form and apply to a variety of substrates
- Easy to clean and maintain

Applications

- High-traffic and high-impact areas
- Corridors
- Classrooms
- Entrances and waiting areas
- Reception desks
- Patient / resident rooms
- Columns

Colours & Texture



Finishes
12



Texture
Suede

See reverse for details.



c-sgroup.eu/16723

Acrovyn® Textured Sheet - Decorative Finishes

Product Details

- 2 mm thick: 3000 x 1250 mm
Custom sizes within standard dimensions available
- Suede finish
The sheet is supplied with a protective film to the face side, which should be removed after installation, once the area is ready for use.
- Woodgrain and metallic pattern direction runs parallel to the 3 m side of sheet
- Can be thermoformed for inside and outside corners
- Straight-cut edge is standard, 45° or round bevel available on request
- Creative designs, signage and logos can be supplied
- Installed with adhesive for permanent fix

Certifications & Testing

- Fire rating class **M1**, classified according to NF P 92-512:1986, test report available on request.
- Does not propagate the growth of bacteria or fungi on a clean surface (tested to EN ISO 846:1997)
- Impact resistant (tested to EN ISO 6603-1:2000)
- VOC emissions class A+ (tested to ISO 16000 principles)

Finishing Accessories

Where temperature fluctuations are expected, small gaps should be left at installation edges, in joint positions and around cutouts to allow the material to expand and contract. The following finishing options are available:

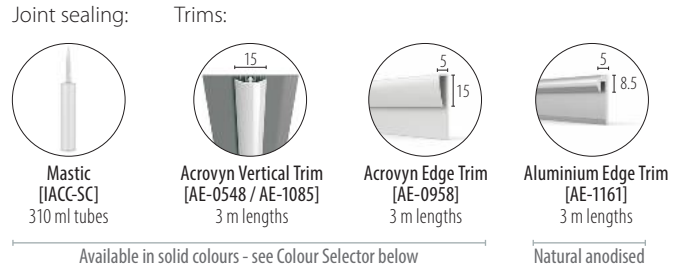

Cleaning & Maintenance

- Can be cleaned using soapy water, commonly used disinfectants or domestic cleaning products.

For Cleaning Guidelines visit: c-sgroup.eu/37968

Warranty & Lifespan

- 2-year product warranty
- Up to 25-year life expectancy

For Terms and Conditions visit: c-sgroup.eu/16727

Colour Selector

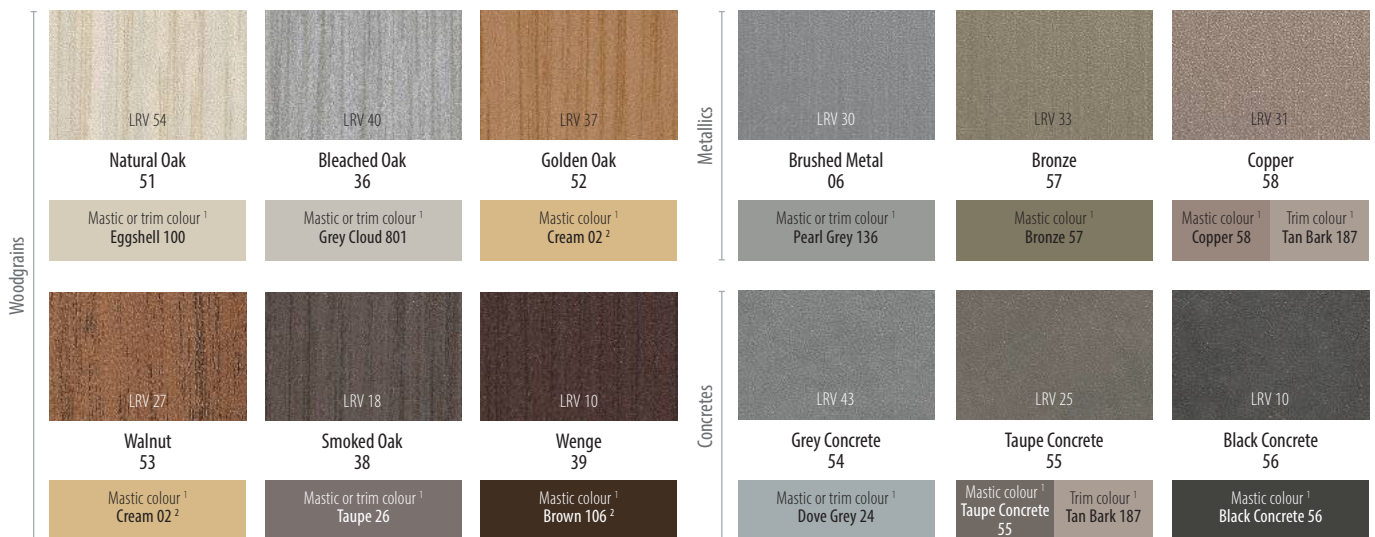

¹ Indicated mastic & trim colours are close matches. Any other mastic colour from our standard range can be used instead, for contrast.

² Special mastic colours (not part of our standard colour range)

LRV (Light Reflectance Value) indicates the amount of light reflected by a surface and can be used to assess the degree of visual contrast between different surfaces. LRV values for Acrovyn colours have been determined using the CIE Y value measurement method.

Acrovyn® Bactericide Sheet



Developed to help combat the threat of hospital acquired infections (HAI), Acrovyn Bactericide Sheet is proven to kill bacteria on contact. Available in textured and smooth variants, it provides a highly resilient, bacteria-free surface finish in areas where hygiene cannot be compromised.



CE Marked



B-s2, d0

Bactericidal
Certified

Class A+

Features & Advantages

- Third party tested to ISO 22196 and proven effective against 7 common hospital and food bacteria species (see reverse for test results)
- Choice of textured or smooth finish
- Through-coloured and impervious material, resistant to most stains and chemicals
- Easy to clean and maintain to a high standard
- Suitable for hot steam cleaning
- Easy to cut, form and apply to a variety of substrates
- Where pedestrian access is expected, complementary HREB-6 handrails with bactericide can be specified (see c-sgroup.eu/6851 for details)

Applications

- Operating theatres
- Post-operating and dialysis areas
- Laboratories
- Kitchens
- Food serving and dining areas
- Food manufacturing

Colours & Texture

Solid Colours
6 (textured), 1 (smooth)Texture
Suede or smooth

See reverse for details.



c-sgroup.eu/7300

Acrovyn® Bactericide Sheet

Product Details

- 2 mm thick: 3000 mm x 1300 mm
Custom sizes within standard dimensions available
- Textured or smooth
- Can be thermoformed for inside and outside corners
- Straight-cut edge is standard, 45° or round bevel available on request
- Installed with adhesive for permanent fix

Certifications & Testing

- Fire rating class **B-s2, d0**, classified according to EN 13501-1, under conditions laid down in the relevant test reports, which are available on request.
- Gross Heat of Combustion (calorific value) - 17,818 MJ/kg (tested to EN ISO 1716)
- Proactively kills bacteria through surface contact alone. Tested to ISO 22196 and classified under EN 1040, as follows:

Bactericidal against:

Escherichia coli



Activity in log:
5.4

Staphylococcus aureus



Activity in log:
5.1

Mycobacterium smegmatis



Activity in log:
>5

Bacteriostatic against:

MRSA



Activity in log:
3.92

Salmonella enteritidis



Activity in log:
4.1

Listeria monocytogenes



Activity in log:
2.661

Enterococcus species



Activity in log:
2.28

Sanitized® zinc pyrithione¹, the advanced anti-microbial additive incorporated during manufacture, remains effective throughout the product's lifespan and is not affected by most stringent cleaning regimes.

¹ Sanitized® is a registered trademark of Sanitized AG

- Impact resistant (tested to EN ISO 6603-1:2000)
- Abrasion resistant (tested to ASTM D 4060)
- Chemically resistant (contact us for further details)
- VOC emissions class A+ (tested to ISO 16000 principles)

Finishing Accessories

Where temperature fluctuations are expected, small gaps should be left at installation edges, in joint positions and around cutouts to allow the material to expand and contract. The following finishing options are available:

Joint sealing:



Mastic [IACC-SC]
All colours, 310 ml tubes



Welding Rod [AE-1127]
All colours, 100 m rolls

Trims:
(3 m lengths)



Acrovyn Vertical Trim [AE-0548 / AE-1085]
All colours (Front)

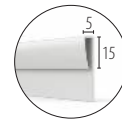

Acrovyn Edge Trim [AE-0958]
All colours

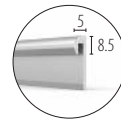

Aluminium Edge Trim [AE-1161]
Natural anodised

Cleaning & Maintenance

- Can be cleaned using soapy water, commonly used disinfectants or domestic cleaning products.
- Can be steam cleaned with suitable attachments, such as mops (150°C hot steam at max 5 bar pressure setting).

For Cleaning Guidelines visit: c-sgroup.eu/37968

Warranty & Lifespan

- 2-year product warranty
- Up to 25-year life expectancy

For Terms and Conditions visit: c-sgroup.eu/16727

Colour Selector

Suede texture:



LRV 86
Snow White 9003



LRV 83
Pure White 9010



LRV 60
Almond Green 1510



LRV 64
Grey Cloud 801



LRV 49
Dove Grey 24



LRV 50
Aqua Blue 11

Smooth:



LRV 86
Snow White 9003

Smooth sheet is supplied with a protective film to the face side, which should be removed after installation, once the area is ready to use.

Other colours from our Acrovyn range can be supplied, subject to minimum order quantity.

LRV (Light Reflectance Value) indicates the amount of light reflected by a surface and can be used to assess the degree of visual contrast between different surfaces. LRV values for Acrovyn colours have been determined using the CIE Y value measurement method.

Acrovyn® PVC-Free Textured Sheet



Offering reliable impact protection to interior surfaces, Acrovyn PVC-Free Sheet also protects the environment. Available in a range of beautiful colours, it has a light texture, making it easy to maintain to a high standard. It can be installed at full or partial height, providing long-lasting protection and enhancing spaces.



CE Marked

B-s1, d0[†]

Class A+



Features & Advantages

- Durable material keeps interiors protected and looking good
- Wide range of colours allows for coordination with any interior design scheme
- Free from PVC, Persistent Bioaccumulative Toxins (PBTs), Bisphenol A (BPA), as well as halogenated or brominated fire retardants
- Bronze certified under Cradle to Cradle Certified® Products Program*
- Through-coloured and textured to conceal scratches and abrasions
- Easy to cut, form and apply to a variety of substrates
- Easy to clean and maintain

Applications

- High-traffic and high-impact areas
- Corridors
- Classrooms
- Entrances and waiting areas
- Wards and patient rooms
- Back of house

Colours & Texture

Solid Colours
36Texture
Suede

See reverse for details.



c-sgroup.eu/8138

*Cradle to Cradle Certified® is a registered trademark of the Cradle to Cradle Products Innovation Institute.

Acrovyn® PVC-Free Textured Sheet

Product Details

- 1.5 mm thick: 3000 x 1300 mm
1 mm thick: 3000 x 1300 mm
Custom sizes within standard dimensions available
- Suede texture
- Can be thermoformed for inside and outside corners
- Straight-cut edge is standard, 45° or round bevel available for 1.5 mm option
- Creative designs, signage and logos can be supplied
- Installed with adhesive for permanent fix

Certifications & Testing

- Fire rating class **B-s1, d0**, classified according to EN 13501-1, under conditions as laid down in the relevant test reports, which are available on request.
- Gross Heat of Combustion (calorific value) - 22,335 MJ/kg (tested to EN ISO 1716)
- Does not propagate the growth of bacteria or fungi on a clean surface (tested to EN ISO 846:1997)
- Impact resistant (tested to EN ISO 6603-1:2000)
- Abrasion resistant (tested to ASTM D 4060)
- Chemically resistant (contact us for further details)
- Cradle to Cradle Certified® Bronze
- VOC emissions class A+ (tested to ISO 16000 principles)
- Environmental Product Declaration (EPD) no. S-P-02037 (independent assessment according to ISO 14025)

Finishing Accessories

Where temperature fluctuations are expected, small gaps should be left at installation edges, in joint positions and around cutouts to allow the material to expand and contract. The following finishing options are available:

Joint sealing * 1.5 mm sheet only



Mastic [IACC-SC]
All colours, 310 ml tubes



Welding Rod* [AE-1006]
All colours, 100 m rolls

Trims 3 m lengths

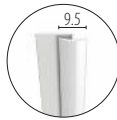

PVC-Free Vertical Trim [AE-1068]
6 colours**

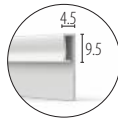

PVC-Free Edge Trim [AE-1069]
6 colours**

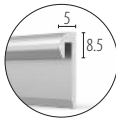

Aluminium Edge Trim [AE-1161]
Natural anodised

Cleaning & Maintenance

- Can be cleaned using soapy water, commonly used disinfectants or domestic cleaning products.
- Can be steam cleaned with suitable attachments, such as mops (150°C hot steam at max 5 bar pressure setting).





































For Cleaning Guidelines visit: c-sgroup.eu/37968

Warranty & Lifespan

- 2-year product warranty
- Up to 25-year life expectancy

For Terms and Conditions visit: c-sgroup.eu/16727

Colour Selector

									
LRV 86	LRV 83	LRV 74	LRV 73	LRV 80	LRV 49	LRV 39	LRV 50	LRV 63	LRV 50
Snow White 9003	Pure White 9010	Mission White 933	Eggshell 100	Misty Grey 260	Dove Grey 24	Pearl Grey 136	Felt 7044	Ice Blue 1015	Aqua Blue 11
									
LRV 64	LRV 40	LRV 24	LRV 7	LRV 22	LRV 14	LRV 10	LRV 8	LRV 32	LRV 24
Grey Cloud 801	Tan Bark 187	Taupe 26	Earth 8019	Charcoal 162	Anthracite 7043	Graphite 7024	Black 108	Cape Blue 325	Pacific Blue 112
									
LRV 70	LRV 66	LRV 47	LRV 15	LRV 60	LRV 56	LRV 31	LRV 13	LRV 20	LRV 8
French Cream 101	Golden Yellow 16	Tangerine 17	Spectrum Red 845	Almond Green 1510	Anise 22	Lagoon 5018	Sequoia Green 6020	Baltic Blue 4030	Yale Blue 129
									
LRV 79	LRV 31	LRV 28	LRV 13	LRV 16	LRV 29				
Powder Pink 510	Coral Blush 2040	Pink Grapefruit 2050	Sugar Plum 32	Imperial Purple 520	Prairie Green 3040				

** Indicates standard trim colours.

LRV (Light Reflectance Value) indicates the amount of light reflected by a surface and can be used to assess the degree of visual contrast between different surfaces. LRV values for Acrovyn colours have been determined using the CIE Y value measurement method.

Acrovyn by Design®



Acrovyn by Design (AbD) is a bespoke wall protection solution, which offers architects, interior designers, and owners the ability to create stunning interiors. Large format custom graphics, photography, messaging or custom colours are printed on the reverse of durable, transparent Acrovyn PVC-Free Sheet, which protects both the artwork and the wall from damage.



Class A+

Features & Advantages

- High quality image reproduction
- Print on the back of transparent sheet ensures the artwork is protected from damage
- Impact, scratch and chip resistant surface, making it suitable for busy areas of any building
- Can be applied to interior walls, doors, counters and other substrates
- Wipe-clean surface, which is highly durable and easy to maintain

Applications

- Entrance lobbies and reception areas
- Corridors
- Wayfinding
- Hospital wards
- Hotel bedrooms
- Classrooms
- Sports venues and fitness centres

Finish Options



Images



Graphics



Wayfinding



Branding



Patterns



Bespoke Colours



Bespoke Woodgrains



c-sgroup.eu/2636

Acrovyn by Design®

Product Details

- Artwork is printed on the reverse of 1 mm thick, transparent Acrovyn PVC-Free Sheet
- Maximum individual sheet size is 3000 x 1270 mm. Large murals consist of multiple sheets, cut as necessary with no additional cutting charge.
- Suede texture
- Digitally printed using a CMYK droplet technology
- Can be thermoformed for inside and outside corners
- Installed with adhesive for permanent fix

Certifications & Testing

- Does not propagate the growth of bacteria or fungi on a clean surface (tested to EN ISO 846:1997)
- Impact resistant (tested to EN ISO 6603-1:2000)
- Abrasion resistant (tested to ASTM D 4060)
- Chemically resistant (contact us for further details)
- VOC emissions class A+ (tested to ISO 16000 principles)
- Print process utilises GREENGUARD Gold certified inks

Artwork Requirements

Image type and quality

- Bitmap images (.jpg, .tif, .psd, or RAW)
Can lose quality if resized too much. For best results check the quality of your image at the actual print size before ordering.
- Vector images (.ai, .eps or .wfm)
These file types are infinitely scalable, so you can be sure of high quality print at any size.



Custom colours

AbD can be printed with a solid colour. However, a CMYK droplet technology used in digital printing is different to a paint mixing process. When colour matching to Pantone or NCS colours for example, it is not always possible to achieve an exact match. If colour matching is critical, we will work on refining colour output within our manufacturing capabilities. Samples of shade variations will be issued for selection.



Finishing Accessories

Where temperature fluctuations are expected, small gaps should be left at installation edges, in joint positions and around cutouts to allow the material to expand and contract. The following finishing options are available:

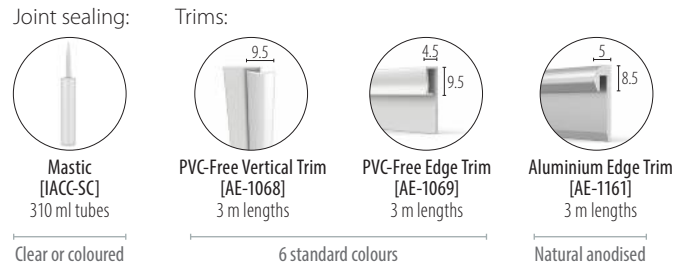

Cleaning & Maintenance

- Can be cleaned using soapy water, commonly used disinfectants or domestic cleaning products.

For Cleaning Guidelines visit: c-sgroup.eu/37968

Warranty & Lifespan

- 2-year product warranty
- Up to 25-year life expectancy

For Terms and Conditions visit: c-sgroup.eu/16727

Copyright

In respect of intellectual property rights of others, a signed Copyright Agreement is required before we proceed with print.

For more information on artwork requirements, and order processing guidance, refer to 'Acrovyn by Design® ordering guide.' Available for download from: c-sgroup.eu/2636



Acrovyn® Stainless Steel Sheet



Stainless steel sheet provides durable surface protection in hygiene sensitive areas and commercial applications. Can be installed over a variety of substrates at full or partial height.



Class A
(non-combustible)

Features & Advantages

- Durable, non-porous surface
- Corrosion resistant
- Long life span
- Easy to clean and maintain
- Complementary Corner Guards and Crash Rails available

Applications

- Kitchens
- Food preparation and serving areas
- Food manufacturing
- Laboratories

Material & Finish



Stainless Steel
Grade 304L



Finish
Brushed



c-sgroup.eu/16637

Acrovyn® Stainless Steel Sheet

Product Details

- 1 mm thick: 2500 x 1250 mm
The sheet is supplied with a protective film to the face side, which should be removed after installation, once the area is ready to use.
- Custom sizes within standard dimensions and edge designs, such as wave pattern, can be supplied
- Type 304L (1.4307) stainless steel alloy
- Brushed finish
- Custom formed angles and channels available
- Installed with adhesive for permanent fix. Sheets are installed butt-jointed.

Certifications & Testing

- Considered as reaction to fire Class A (non-combustible) without the need for testing (96/603/EC, updated with 2000/605/EC)

Cleaning & Maintenance

- Can be cleaned using soapy water or commonly used, non-abrasive domestic cleaning products.

For Cleaning Guidelines visit: c-sgroup.eu/37968

Warranty & Lifespan

- 2-year product warranty
- Life expectancy over 25 years

For Terms and Conditions visit: c-sgroup.eu/16727



Acrovyn®
Wall Panels



Acrovyn® Wall Panels



Where heavy duty wall protection is required, Acrovyn Wall Panels provide a cost effective and long lasting solution. Manufactured to custom sizes and specifications by adhering one of our impact resistant sheet options to a rigid board, Acrovyn Wall Panels provide a very durable and easy to maintain surface to the entire wall, or just to part height.

Features & Advantages

- Durable Acrovyn enhances interiors while keeping them protected
- Choice of panel facings
- Impact, scratch and abrasion resistant surface
- Choice of panel edge styles
- Choice of panel boards to suit project requirements
- Permanent installation using adhesive
- Easy to clean and maintain

Applications

- Corridors
- Lift areas
- Back-of-house areas
- Full or partial height applications

Colours & Texture



See reverse for details.



c-sgroup.eu/835

Acrovyn® Wall Panels

Product Details

- Panel facing options:
 - 2 mm Acrovyn Sheet, Suede, 36 colours
 - 1.5 mm Acrovyn PVC-Free Sheet, Suede, 36 colours
 - 2 mm Acrovyn Smooth Sheet, 10 colours *
- Panel board options:
 - 9 mm MDF (standard)
 - 9 mm moisture resistant MDF (optional)
 - MDF fire tested to EN 13501 (optional)

Other board thicknesses can be offered.
- Panel size: 2400 x 1200 mm (standard)

Sizes within those dimensions can be supplied.

Larger panels can be manufactured on request, max 2960 x 1200 mm.
- Panel edge options:

Unfinished



Acrovyn applied only to the face of the board. Edge trims recommended for partial height installations.

2-side wrapped



Acrovyn square wrapped on two long sides of the board. Ideal for partial height installations, eliminates the need for top/bottom edge trims.

4-side wrapped



All four panel edges are finished with Acrovyn. Not suitable for cutting to size on-site, apart from internal corner fitting.

- Installed with adhesive for permanent fix

Finishing Accessories

Mastic

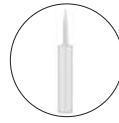

For sealing of joints between panels and around cut-outs. All colours, 310 ml tubes.

Aluminium edge trim

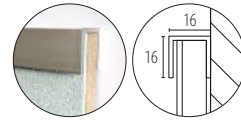

For covering exposed, unfinished panel edges. Natural anodised, 2.5 m lengths.

SO Series Corner Guards



For use over overlapped panels in external corner positions. All colours, 3 leg sizes, 3 m lengths.

Certifications & Testing

- Acrovyn panel facings have been tested for fire performance, impact and abrasion resistance, anti-microbial resistance and VOC emissions. For details refer to individual Product Sheets.
- Acrovyn Wall Panels utilise non-fire rated MDF as standard. If required, Class B or Class C fire rated MDF board can be used in panel manufacturing.

Cleaning & Maintenance

- Can be cleaned using soapy water, commonly used disinfectants or domestic cleaning products.





































For Cleaning Guidelines visit: c-sgroup.eu/37968

Warranty & Lifespan

- 2-year product warranty
- Life expectancy up to 25 years

For Terms and Conditions visit: c-sgroup.eu/16727

Colour Selector

 LRV 86	 LRV 83	 LRV 74	 LRV 73	 LRV 80	 LRV 49	 LRV 39	 LRV 50	 LRV 63	 LRV 50
 LRV 64	 LRV 40	 LRV 24	 LRV 7	 LRV 22	 LRV 14	 LRV 10	 LRV 8	 LRV 32	 LRV 24
 LRV 70	 LRV 66	 LRV 47	 LRV 15	 LRV 60	 LRV 56	 LRV 31	 LRV 13	 LRV 20	 LRV 8
 LRV 79	 LRV 31	 LRV 28	 LRV 13	 LRV 16	 LRV 29	* Indicates Acrovyn Smooth Sheet colours.			

LRV (Light Reflectance Value) indicates the amount of light reflected by a surface and can be used to assess the degree of visual contrast between different surfaces. LRV values for Acrovyn colours have been determined using the CIE Y value measurement method.

Acrovyn® FP Panels



Robust, A2 fire rated wall panels designed for areas with high performance requirements.



A2-s1, d0



Class A+

Features & Advantages

- Durable, rigid wall panels providing a resilient finish in areas with A2 fire rating requirements
- 12.5mm thick, comprising gypsum fibre board with a lightly textured and highly durable surface coating
- Wide choice of colour options and a range of finishing trims available
- Supplied prefabricated to project specific sizes
- Installed with A2 rated adhesive for permanent fix

Applications

- Corridors and escape routes with A2 fire rating requirement
- Entrance and lift areas
- Suitable for full and part height wall applications

Colours & Texture



Solid Colours
Acrovyn or RAL colours



Texture
Fine

See reverse for details.



c-sgroup.eu/10912

Acrovyn® FP Panels

Product Details

- 12.5 mm thick panels, comprising A1 rated gypsum fibre board with a lightly textured, UV hardened, acrylic surface coating
- Panel sizes:
 - Partial height applications - 1250 mm (W) x up to 1250 mm (H)
 - Full height applications - 1250 mm (W) x up to 2530 mm (H)

Panels are prefabricated to project specific sizes. Cutting on-site should be avoided, except for resizing panels to suit internal corners or making cut-outs.

Panel weight should be taken into consideration for handling and installation (18.75 kg/m²). The substrate to which panels are adhered to should have a suitable load-bearing capacity. To ensure high quality of installation, walls should also be plumb (max. deviation on a 2.5 m storey height is 10 mm).

- Panel finishing:

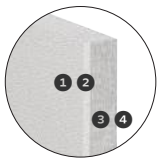

- 1 Lightly textured, coloured coating in a matt finish
- 2 Small bevel to vertical panel edges on the face-side
- 3 Panel sides are straight-cut and uncoated
- 4 Panels are coated on the reverse for balancing purposes

Cleaning & Maintenance

- Can be cleaned using soapy water, commonly used disinfectants or domestic cleaning products.

For Cleaning Guidelines visit: c-sgroup.eu/37968

Warranty & Lifespan

- 2-year product warranty
- Life expectancy up to 25 years

For Terms and Conditions visit: c-sgroup.eu/16727

Finishing Accessories

Mastic



For sealing of joints between panels and around cut-outs. All Acrovyn colours, range of RAL colours, 310 ml tubes.

Aluminium edge trim

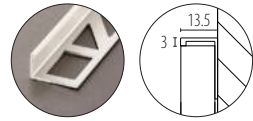

For covering exposed panel edges. White RAL 9016 coated or clear anodised as standard. Other options available. 2.5 or 3 m lengths.

Stainless steel edge trim

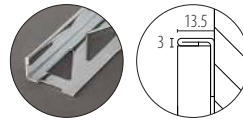

For covering exposed panel edges. Chrome plated, bright or brushed finish. 2.5 or 3 m lengths.

Stainless steel corner guards

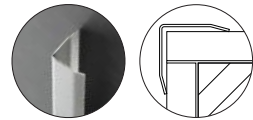

For use in external corner positions. Choice of leg sizes (25, 30, 40 or 50 mm), brushed finish. 2, 2.5 or 3 m lengths, depending on size.

Certifications & Testing

- Fire rating class A2-s1, d0 according to EN 13501-1. Panels must be installed to a substrate of reaction to fire class A1 or A2-s1, d0 using A2 rated Hensomastik K2000 adhesive. Test reports available on request.
- VOC emissions class A+ (tested to ISO 16000 principles)
- Abrasion resistant (tested to ASTM D 4060) - 1200 cycles
- Scratch resistant (tested to EN ISO 22557:2021-02) - >12N
- Surface coating incorporates anti-microbial, non-volatile silver ions, which actively inhibit and disrupt the growth of bacteria on the surface. Tested to ISO 22196:2011 for efficacy against 2 bacteria species.

Colour Selector *

Snow White 9003	Pure White 9010	Mission White 933	Eggshell 100	Misty Grey 260	Dove Grey 24	Pearl Grey 136	Felt 7044	Ice Blue 1015	Aqua Blue 11
Grey Cloud 801	Tan Bark 187	Taupe 26	Earth 8019	Charcoal 162	Anthracite 7043	Graphite 7024	Black 108	Cape Blue 325	Pacific Blue 112
French Cream 101	Golden Yellow 16	Tangerine 17	Spectrum Red 845	Almond Green 1510	Anise 22	Lagoon 5018	Sequoia Green 6020	Baltic Blue 4030	Yale Blue 129
Powder Pink 510	Coral Blush 2040	Pink Grapefruit 2050	Sugar Plum 32	Imperial Purple 520	Prairie Green 3040				

* Coating can be matched to any of our standard Acrovyn colours. Alternatively, it can be matched to RAL colour range.

Acrovyn[®]
Corner Guards



SM-20

76 mm leg corner guards featuring a robust aluminium retainer and a free-floating Acrovyn cover, preventing damage to corners from impact caused by wheeled traffic.



Heavy Duty

Features & Advantages

- 76 mm leg corner guards designed for 90° corners
- Impact resistant, textured snap-on cover
- Free-floating cover flexes on impact, absorbing its force
- Continuous aluminium retainer for heavy duty impact protection
- Available in full or partial heights
- Easily replaceable cover and end caps

Applications

- Corridor walls and columns
- Lift lobbies
- Reception and waiting areas
- Food serving and dining areas

Colours & Texture



Solid Colours
27



Texture
Shadowgrain

See reverse for details.



c-sgroup.eu/2551



SM-20

Surface Mounted

90° corners



SM-20

Accessories

- Supplied with top and bottom end caps

Stock Lengths & Fixings

- Cut to required size from 3 m stock lengths
- Fix at staggered 400 mm centres

Warranty & Lifespan

- 2-year product warranty
- Up to 25-year life expectancy

For Terms and Conditions visit: c-sgroup.eu/16727

Colour Selector

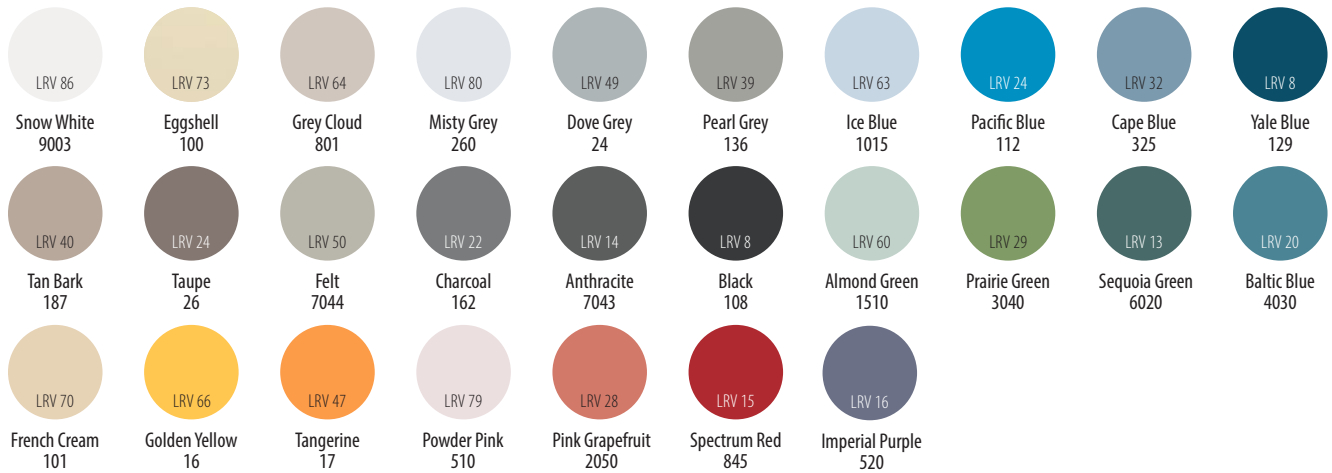

LRV (Light Reflectance Value) indicates the amount of light reflected by a surface and can be used to assess the degree of visual contrast between different surfaces. LRV values for Acrovyn colours have been determined using the CIE Y value measurement method.

SSM-20

51 mm leg corner guards featuring a robust aluminium retainer and a free-floating Acrovyn cover, preventing damage to corners in busy circulation areas.



Heavy Duty

Features & Advantages

- 51 mm leg corner guards designed for 90° corners
- Impact resistant, textured snap-on cover
- Free-floating cover flexes on impact, absorbing its force
- Continuous aluminium retainer for heavy duty impact protection
- Available in full or partial heights
- Easily replaceable cover and end caps

Applications

- Corridor walls and columns
- Lift lobbies
- Reception and waiting areas
- Food serving and dining areas

Colours & Texture



Solid Colours
27



Finishes
12



Texture
Shadowgrain

See reverse for details.



c-sgroup.eu/398



SSM-20

Surface Mounted

90° corners



SSM-20

Accessories

- Supplied with top and bottom end caps

Stock Lengths & Fixings

- Cut to required size from 3 m stock lengths
- Fix at staggered 400 mm centres

Warranty & Lifespan

- 2-year product warranty
- Life expectancy up to 25 years

For Terms and Conditions visit: c-sgroup.eu/16727

Colour Selector

Solid Colours										
Finishes										

LRV (Light Reflectance Value) indicates the amount of light reflected by a surface and can be used to assess the degree of visual contrast between different surfaces. LRV values for Acrovyn colours have been determined using the CIE Y value measurement method.

SM-20M

76 mm leg corner guards featuring a robust aluminium retainer and a free-floating Acrovyn cover, designed to protect 135° corners from impact damage.



Heavy Duty

Features & Advantages

- 76 mm leg corner guards designed for 135° corners
- Impact resistant, textured snap-on cover
- Free-floating cover flexes on impact, absorbing its force
- Continuous aluminium retainer for heavy duty impact protection
- Available in full or partial heights
- Easily replaceable cover and end caps

Applications

- Corridor walls and columns
- Lift lobbies
- Reception and waiting areas
- Food serving and dining areas

Colours & Texture



Solid Colours
27



Texture
Shadowgrain

See reverse for details.



c-sgroup.eu/16632



SM-20M

Surface Mounted

135° corners



SM-20M

Accessories

- Supplied with top and bottom end caps

Stock Lengths & Fixings

- Cut to required size from 3 m stock lengths
- Fix at 400 mm centres

Warranty & Lifespan

- 2-year product warranty
- Up to 25-year life expectancy

For Terms and Conditions visit: c-sgroup.eu/16727

Colour Selector

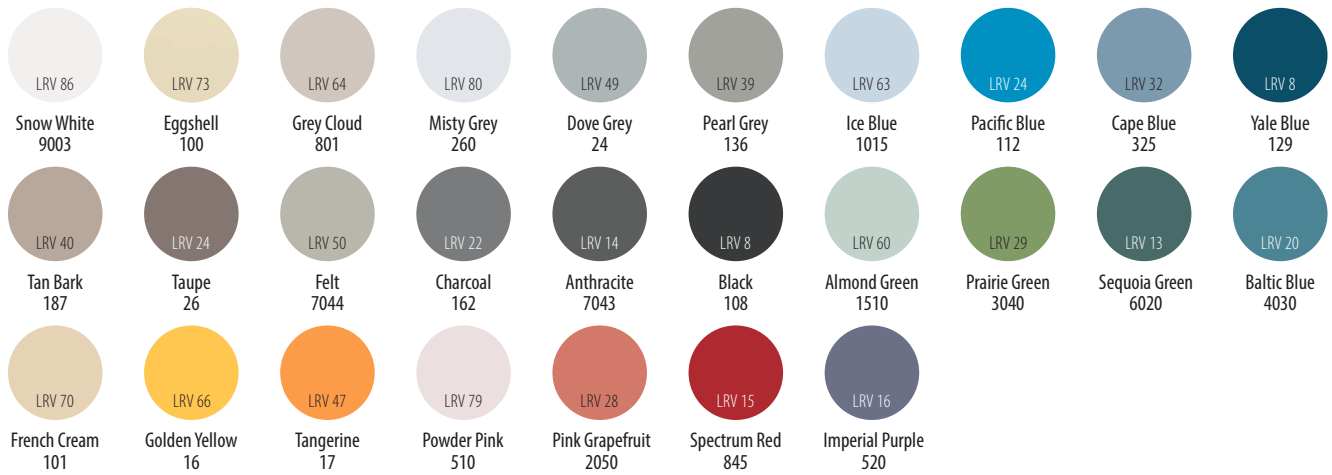

LRV (Light Reflectance Value) indicates the amount of light reflected by a surface and can be used to assess the degree of visual contrast between different surfaces. LRV values for Acrovyn colours have been determined using the CIE Y value measurement method.

SO Series

A range of simple to install corner guards offering economical protection from damage caused by pedestrian and wheeled traffic.



Medium Duty

Features & Advantages

- 30, 50 or 75 mm leg corner guards for 90° corners
- 50 mm leg co-extruded guard with a flexible corner for angles between 80° and 175° (SO-50V)
- Easy installation with self-adhesive double-sided tape or construction adhesive
- Available in full or partial heights
- A wide range of colours to easily co-ordinate with any interior design scheme

Applications

- Corridor walls and columns
- Lift lobbies
- Reception and waiting areas
- Food serving and dining areas

Colours & Texture



Solid Colours
36



Finishes (SO-50 only)
12



Texture
Shadowgrain

See reverse for details.



c-sgroup.eu/8495

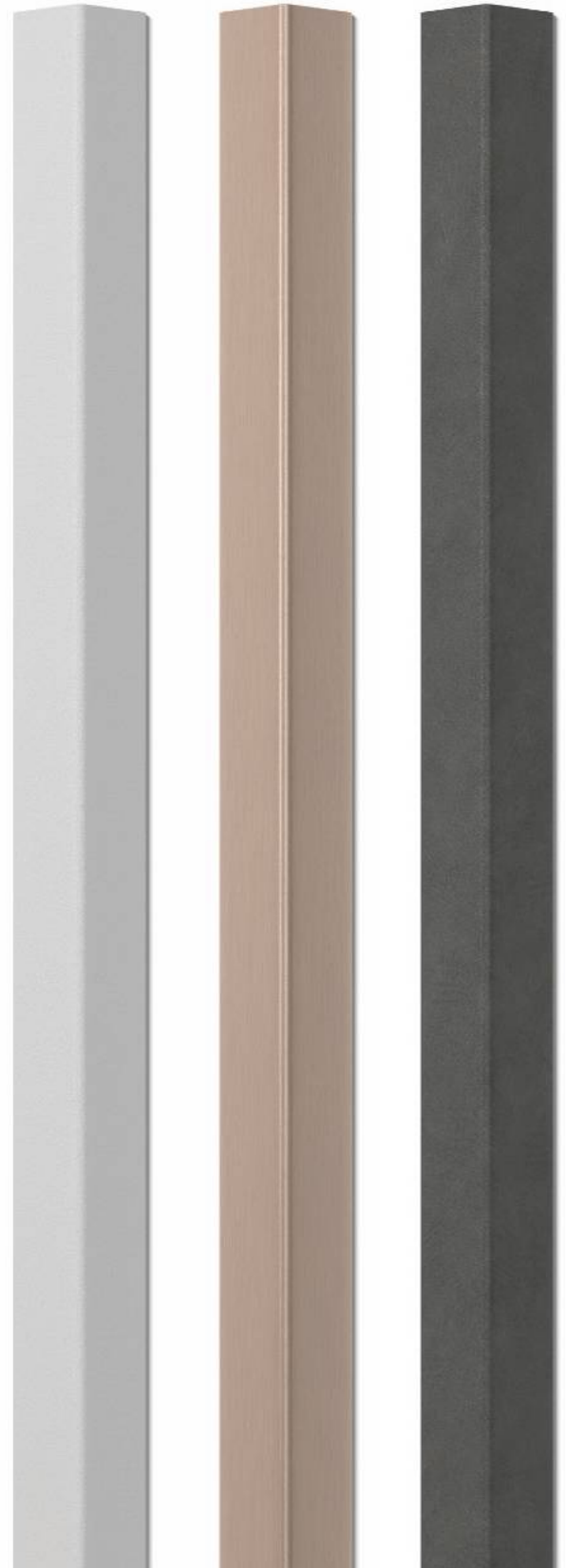

SO Series

Surface Mounted

90° corners



80°-175° corners



- SO-30 (30 mm leg)
- SO-50 (50 mm leg)
- SO-75 (75 mm leg)

SO-50V

Accessories

- Can be supplied with or without double-sided tape

Stock Lengths & Fixings

- Cut to required size from 3 m stock lengths
- Installation using self-adhesive double-sided tape or construction adhesive

Warranty & Lifespan

- 2-year product warranty
- Up to 25-year life expectancy

For Terms and Conditions visit: c-sgroup.co.uk/16727

Colour Selector

Solid Colours - all models	LRV 86	LRV 83	LRV 74	LRV 73	LRV 80	LRV 49	LRV 39	LRV 50	LRV 63	LRV 50	
	Snow White 9003	Pure White 9010	Mission White 933	Eggshell 100	Misty Grey 260	Dove Grey 24	Pearl Grey 136	Felt 7044	Ice Blue 1015	Aqua Blue 11	
	LRV 64	LRV 40	LRV 24	LRV 7	LRV 22	LRV 14	LRV 10	LRV 8	LRV 32	LRV 24	
	Grey Cloud 801	Tan Bark 187	Taupe 26	Earth 8019	Charcoal 162	Anthracite 7043	Graphite 7024	Black 108	Cape Blue 325	Pacific Blue 112	
	LRV 70	LRV 66	LRV 47	LRV 15	LRV 60	LRV 56	LRV 31	LRV 13	LRV 20	LRV 8	
	French Cream 101	Golden Yellow 16	Tangerine 17	Spectrum Red 845	Almond Green 1510	Anise 22	Lagoon 5018	Sequoia Green 6020	Baltic Blue 4030	Yale Blue 129	
	LRV 79	LRV 31	LRV 28	LRV 13	LRV 16	LRV 29					
	Powder Pink 510	Coral Blush 2040	Pink Grapefruit 2050	Sugar Plum 32	Imperial Purple 520	Prairie Green 3040					
	Finishes - SO-50 only	LRV 54	LRV 37	LRV 27	LRV 40	LRV 18	LRV 10				
		Natural Oak 51	Golden Oak 52	Walnut 53	Bleached Oak 36	Smoked Oak 38	Wenge 39				
LRV 30		LRV 33	LRV 31	LRV 43	LRV 25	LRV 10					
Brushed Metal 06		Bronze 57	Copper 58	Grey Concrete 54	Taupe Concrete 55	Black Concrete 56					

LRV (Light Reflectance Value) indicates the amount of light reflected by a surface and can be used to assess the degree of visual contrast between different surfaces. LRV values for Acrovyn colours have been determined using the CIE Y value measurement method.

SM-20N

76 mm leg corner guards featuring a robust aluminium retainer and a free-floating Acrovyn PVC-Free cover, preventing damage to corners from impact caused by wheeled traffic.



Heavy Duty

Features & Advantages

- 76 mm leg corner guards designed for 90° corners
- Impact resistant, textured snap-on cover
- Free-floating cover flexes on impact, absorbing its force
- Continuous aluminium retainer for heavy duty impact protection
- Available in full or partial heights
- Easily replaceable cover and end caps

Applications

- Corridor walls and columns
- Lift lobbies
- Reception and waiting areas
- Food serving and dining areas

Colours & Texture



Solid Colours
15



Texture
Shadowgrain

See reverse for details.



c-sgroup.eu/2551



SM-20N

Surface Mounted

90° corners



SM-20N

Accessories

- Supplied with top and bottom end caps

Stock Lengths & Fixings

- Cut to required size from 3 m stock lengths
- Fix at staggered 400 mm centres

Warranty & Lifespan

- 2-year product warranty
- Up to 25-year life expectancy

For Terms and Conditions visit: c-sgroup.co.uk/16727

Colour Selector

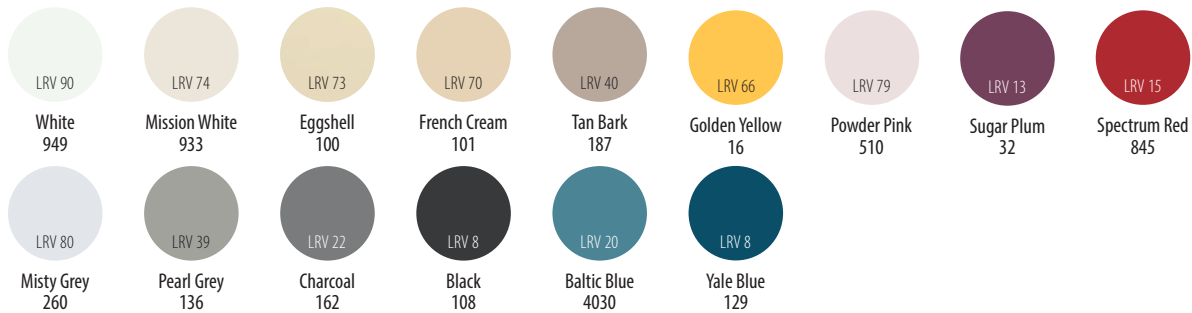

LRV (Light Reflectance Value) indicates the amount of light reflected by a surface and can be used to assess the degree of visual contrast between different surfaces. LRV values for Acrovyn colours have been determined using the CIE Y value measurement method.

SSM-20N

51 mm leg corner guards featuring a robust aluminium retainer and a free-floating Acrovyn PVC-Free cover, preventing damage to corners in busy circulation areas.



Heavy Duty

Features & Advantages

- 51 mm leg corner guards designed for 90° corners
- Impact resistant, textured snap-on cover
- Free-floating cover flexes on impact, absorbing its force
- Continuous aluminium retainer for heavy duty impact protection
- Available in full or partial heights
- Easily replaceable cover and end caps

Applications

- Corridor walls and columns
- Lift lobbies
- Reception and waiting areas
- Food serving and dining areas

Colours & Texture



Solid Colours
15



Texture
Shadowgrain

See reverse for details.



c-sgroup.eu/398



SSM-20N

Surface Mounted

90° corners



SSM-20N

Accessories

- Supplied with top and bottom end caps

Stock Lengths & Fixings

- Cut to required size from 3 m stock lengths
- Fix at staggered 400 mm centres

Warranty & Lifespan

- 2-year product warranty
- Up to 25-year life expectancy

For Terms and Conditions visit: c-sgroup.eu/16727

Colour Selector

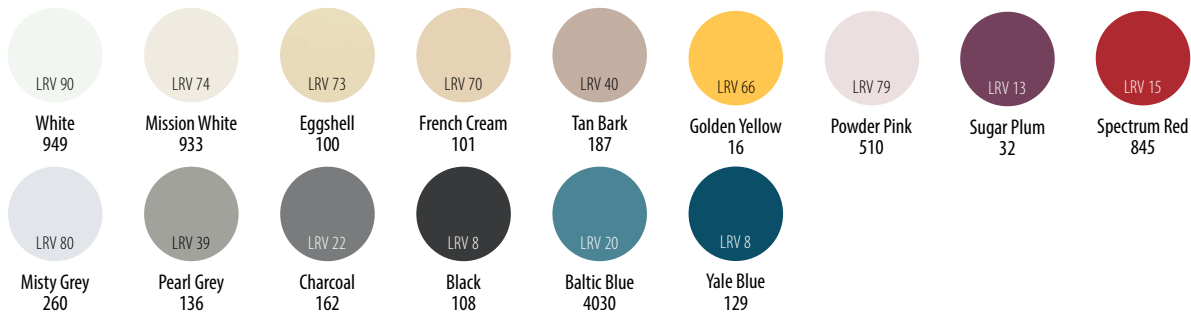

LRV (Light Reflectance Value) indicates the amount of light reflected by a surface and can be used to assess the degree of visual contrast between different surfaces. LRV values for Acrovyn colours have been determined using the CIE Y value measurement method.

TF-N

Manufactured to order and simple to install thermoformed guards, designed to provide protection to corners prone to damage.



Medium Duty



Features & Advantages

- PVC-Free corner guards for 90° corners
- Thermoformed from 1.5 mm Acrovyn PVC-Free Sheet, Cradle to Cradle Certified® Bronze
- Available in leg sizes and heights to suit project needs
- Supplied with straight edges for butting up to sheet for a continuous run, or bevelled (round or 45° options)
- Easy installation with self-adhesive double-sided tape or construction adhesive
- A wide range of colours to easily co-ordinate with any interior design scheme

Applications

- Corridor walls and columns
- Lift lobbies
- Reception and waiting areas
- Food serving and dining areas

Colours & Texture



Solid Colours
36



Texture
Suede

See reverse for details.

* Cradle to Cradle Certified® is a registered trademark of the Cradle to Cradle Products Innovation Institute.



c-sgroup.eu/16631



TF-N

Surface Mounted

90° corners



TF-N

Leg size: min 30 mm, max 645 mm

Accessories

- Can be supplied with or without double-sided tape
- Edge options:



Straight



Round bevel



45° bevel

Stock Lengths & Fixings





































- Manufactured to required size, max 2.9 m
- Installation using self-adhesive double-sided tape or construction adhesive

Warranty & Lifespan

- 2-year product warranty
- Up to 25-year life expectancy

For Terms and Conditions visit: c-sgroup.eu/16727

Colour Selector

 LRV 86 Snow White 9003	 LRV 83 Pure White 9010	 LRV 74 Mission White 933	 LRV 73 Eggshell 100	 LRV 80 Misty Grey 260	 LRV 49 Dove Grey 24	 LRV 39 Pearl Grey 136	 LRV 50 Felt 7044	 LRV 63 Ice Blue 1015	 LRV 50 Aqua Blue 11
 LRV 64 Grey Cloud 801	 LRV 40 Tan Bark 187	 LRV 24 Taupe 26	 LRV 7 Earth 8019	 LRV 22 Charcoal 162	 LRV 14 Anthracite 7043	 LRV 10 Graphite 7024	 LRV 8 Black 108	 LRV 32 Cape Blue 325	 LRV 24 Pacific Blue 112
 LRV 70 French Cream 101	 LRV 66 Golden Yellow 16	 LRV 47 Tangerine 17	 LRV 15 Spectrum Red 845	 LRV 60 Almond Green 1510	 LRV 56 Anise 22	 LRV 31 Lagoon 5018	 LRV 13 Sequoia Green 6020	 LRV 20 Baltic Blue 4030	 LRV 8 Yale Blue 129
 LRV 79 Powder Pink 510	 LRV 31 Coral Blush 2040	 LRV 28 Pink Grapefruit 2050	 LRV 13 Sugar Plum 32	 LRV 16 Imperial Purple 520	 LRV 29 Prairie Green 3040				

LRV (Light Reflectance Value) indicates the amount of light reflected by a surface and can be used to assess the degree of visual contrast between different surfaces. LRV values for Acrovyn colours have been determined using the CIE Y value measurement method.

A Series

Surface mounted stainless steel corner guards offering heavy duty protection to external corners susceptible to damage.



Heavy Duty

Features & Advantages

- Manufactured from 1 mm thick stainless steel
- Cranked edges provide a slight void behind corner guards to accommodate wall irregularities
- Available in three leg sizes to suit project requirements
- Designed to suit 90° corners as standard. Custom angles can be supplied on request.
- Installed using construction adhesive or can be mechanically fastened

Applications

- Kitchens and food serving areas
- Laboratories
- Pharmaceutical manufacturing
- Food manufacturing
- Retail areas
- Back of house areas

Material & Finish



Stainless Steel
Grade 304L



Finish
Brushed



c-sgroup.eu/8505



A Series

Surface Mounted

90° corners *



- 30A (30 mm leg)
- 50A (50 mm leg)
- 75A (75 mm leg)

** Custom angles can be supplied on request*

Stock Lengths & Fixings

- Stock lengths: 3 m
- Installation using construction adhesive (can be supplied if required) or mechanical fasteners

Warranty & Lifespan

- 2-year product warranty
- Life expectancy over 25 years

For Terms and Conditions visit: c-sgroup.eu/16727



C Series

EPDM rubber corner guards offering superior protection and shock-absorbing qualities to areas prone to intense damage.



Severe Duty

Features & Advantages

- Robust, EPDM rubber corner guards
- Available in 75 or 100 mm leg sizes, to suit project requirements
- Low maintenance solution, suitable for interior and exterior applications
- 100C model is grooved on the internal surface to afford greater adhesion
- Installation using construction adhesive and/or proprietary fastenings

Applications

- Service corridors
- Back of house areas
- Loading bays
- Baggage reclaim
- Warehouses
- Car parks

Material & Colour



EPDM Rubber
Black



c-sgroup.eu/411



C Series

Surface Mounted

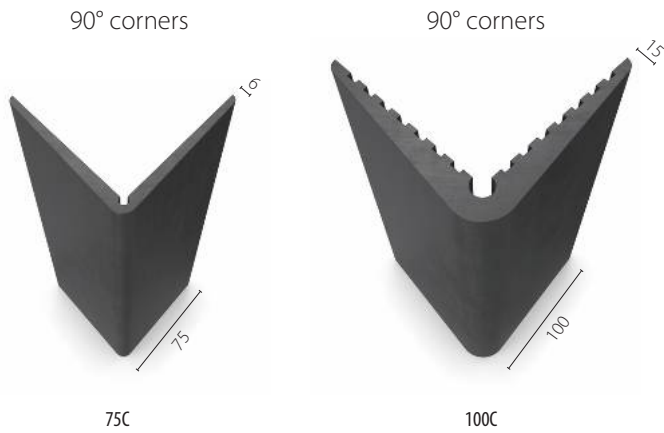

Stock Lengths & Fixings

- Stock lengths: 3 m
- 75C: mechanical fixing at max 300 mm staggered centres, or construction adhesive
- 100C: mechanical fixing at max 300 mm staggered centres and construction adhesive

Warranty & Lifespan

- 2-year product warranty
- Life expectancy over 25 years

For Terms and Conditions visit: c-sgroup.eu/16727

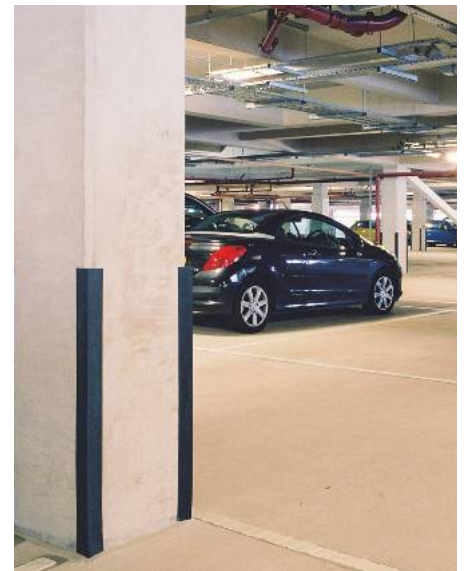

Acrovyn[®]
Handrails



HREB-6



40 mm circular handrails featuring smooth covers with bactericidal additives, providing sturdy pedestrian support in hygienic environments.



Medium Duty



Bactericidal
Certified

Features & Advantages

- Ergonomically designed, 40 mm Ø handrail
- Smooth Acrovyn Bactericide cover in a wide range of standard colours
- Bactericidal additives* in the cover pro-actively kill bacteria on its surface (tested to ISO 22196), and remain effective throughout the product's lifespan
- Continuous aluminium retainer for sturdy support
- Infill strip closes off retainer groove for ease of cleaning
- Choice of brackets
- Can be installed to curved walls (min 1 m radius)

Applications

- Hospitals, care homes, schools, and other buildings where handrail support may be required
- Corridors
- Staircases

Colours & Texture



Solid Colours
27



Texture
Smooth

See reverse for details.



c-sgroup.eu/6851

* Acrovyn Bactericide material contains Sanitized® zinc pyrithione as an antimicrobial additive. Sanitized® is a registered trademark of Sanitized AG.

HREB-6

Mounting Options

Aluminium brackets

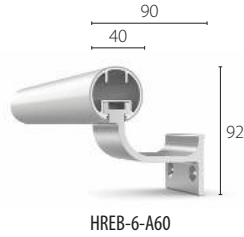

Stainless steel brackets

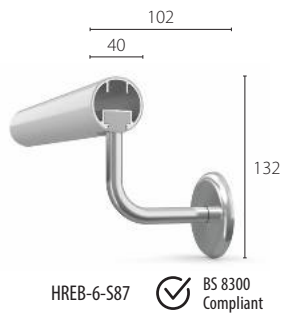
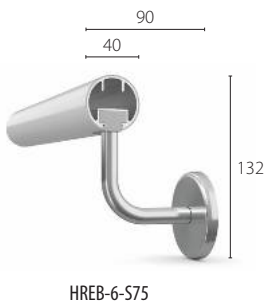

Accessories

- End caps or end stops
- External, internal and odd angle corners (120° - 165°)
- Stainless steel or aluminium brackets (including option for radiused installations)
- Optional vertical accent trims - black (standard) or light grey
- Universal corner adaptors for staircase installations 
- Removable kit for service ducts

Stock Lengths & Fixings

- Stock lengths: 4 m
- Brackets at max 800 mm centres; fixing into studwork or pattresses is recommended

Warranty & Lifespan

- 2-year product warranty
- Up to 25-year life expectancy

For Terms and Conditions visit: c-sgroup.eu/16727

Certification & Testing

Tested to ISO 22196 and classified under EN 1040.

Bactericidal against:

Escherichia coli



Activity in log: 5.4

Staphylococcus aureus



Activity in log: 5.1

Mycobacterium smegmatis



Activity in log: >5

Bacteriostatic against:

MRSA



Activity in log: 3.92

Salmonella enteritidis



Activity in log: 4.1

Listeria monocytogenes







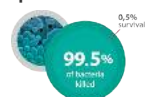





















Activity in log: 2.661

Enterococcus species



Activity in log: 2.28

Colour Selector

 LRV 86	 LRV 73	 LRV 64	 LRV 80	 LRV 49	 LRV 39	 LRV 63	 LRV 24	 LRV 32	 LRV 8
 LRV 40	 LRV 24	 LRV 50	 LRV 22	 LRV 14	 LRV 8	 LRV 60	 LRV 29	 LRV 13	 LRV 20
 LRV 70	 LRV 66	 LRV 47	 LRV 79	 LRV 28	 LRV 15	 LRV 16			

LRV (Light Reflectance Value) indicates the amount of light reflected by a surface and can be used to assess the degree of visual contrast between different surfaces. LRV values for Acrovyn colours have been determined using the CIE Y value measurement method.

HRE-6

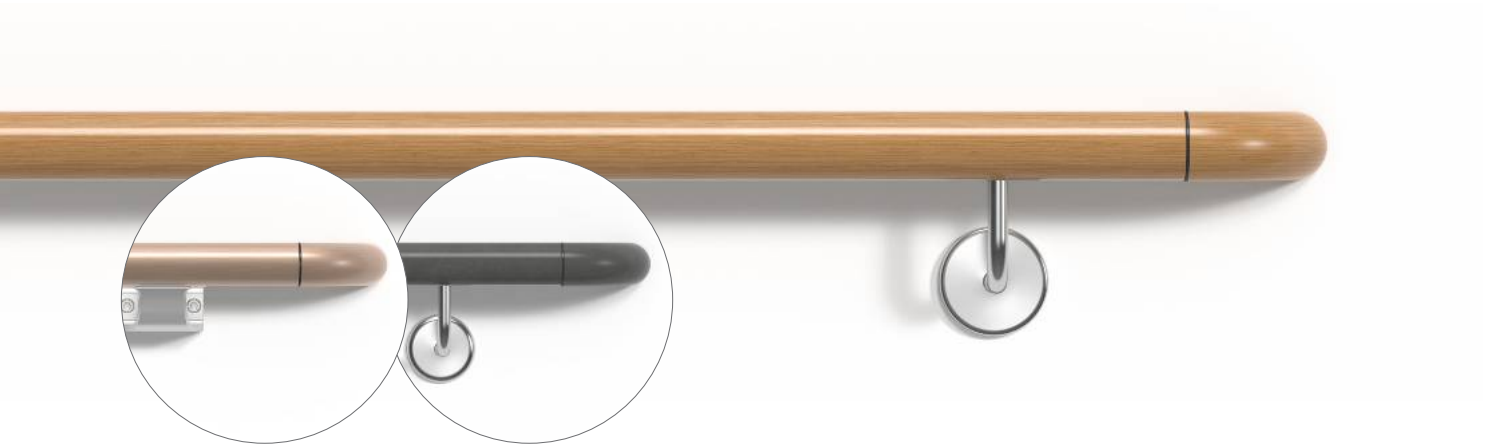

40 mm circular handrails combining contemporary decorative finishes with ease of maintenance of Acrovyn.



Medium Duty

Features & Advantages

- Ergonomically designed, 40 mm Ø handrail
- Smooth Acrovyn cover in a range of woodgrain, metallic and concrete finishes
- Continuous aluminium retainer for sturdy support
- Infill strip closes off retainer groove for ease of cleaning
- Choice of brackets
- Can be installed to curved walls (min 1 m radius)

Applications

- Hospitals, care homes, schools, and other buildings where handrail support may be required
- Corridors
- Staircases

Colours & Texture



Finishes
12



Texture
Smooth

See reverse for details.



c-sgroup.eu/6853

HRE-6

Mounting Options

Aluminium brackets

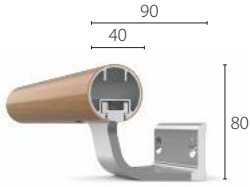

HRE-6-A80



HRE-6-A60

Stainless steel brackets

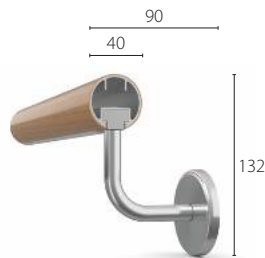

HRE-6-S75

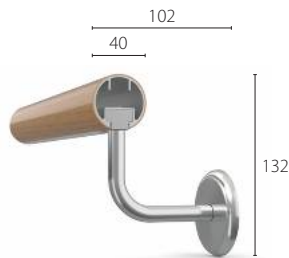

HRE-6-S87



Accessories

- End caps or end stops
- External, internal and odd angle corners (120° - 165°)
- Stainless steel or aluminium brackets (including option for radiused installations)
- Optional vertical accent trims - black (standard) or light grey
- Universal corner adaptors for staircase installations (available in 27 solid colours)
- Removable kit for service ducts

Stock Lengths & Fixings

- Stock lengths: 4 m
- Brackets at max 800 mm centres; fixing into studwork or pattresses is recommended

Warranty & Lifespan

- 2-year product warranty
- Up to 25-year life expectancy

For Terms and Conditions visit: c-sgroup.eu/16727

Colour Selector



LRV (Light Reflectance Value) indicates the amount of light reflected by a surface and can be used to assess the degree of visual contrast between different surfaces. LRV values for Acrovyn finishes have been determined using the CIE Y value measurement method.

HRO-6



38 mm wide, ergonomically designed oval handrails providing firm support in circulation corridors.



Medium Duty

Features & Advantages

- Comfortable grip, 38 mm wide, oval handrail
- Durable, textured Acrovyn cover available in a range of solid colours and decorative finishes
- Continuous aluminium retainer for sturdy support
- Infill strip closes off retainer groove for ease of cleaning
- Choice of brackets

Applications

- Hospitals, care homes, schools, and other buildings where handrail support may be required
- Corridors

Colours & Texture



Solid Colours
27



Finishes
12



Texture
Shadowgrain

See reverse for details.



c-sgroup.eu/6847

HRO-6

Mounting Options

Aluminium brackets



HRO-6-A80

Stainless steel brackets

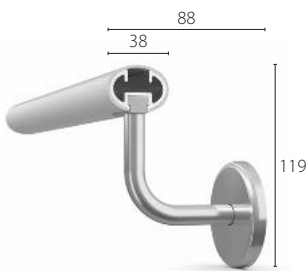

HRO-6-S75

Accessories

- End caps
- External corners
- Internal corners available for handrails in solid colours
- End stops in black or grey
- Stainless steel or aluminium brackets
- Optional vertical accent trims - black (standard) or light grey
- Removable kit for service ducts

Stock Lengths & Fixings

- Stock lengths: 4 m
- Brackets at max 800 mm centres; fixing into studwork or pattresses is recommended

Warranty & Lifespan

- 2-year product warranty
- Up to 25-year life expectancy

For Terms and Conditions visit: c-sgroup.eu/16727

Colour Selector

Solid Colours											
Finishes											

LRV (Light Reflectance Value) indicates the amount of light reflected by a surface and can be used to assess the degree of visual contrast between different surfaces. LRV values for Acrovyn colours have been determined using the CIE Y value measurement method.

HR-6N



40 mm circular handrails featuring textured Acrovyn PVC-Free cover, providing comfortable mobility support in corridors.



Medium Duty

Features & Advantages

- Ergonomically designed, 40 mm Ø handrail
- Durable, textured Acrovyn PVC-Free cover
- Continuous aluminium retainer for sturdy support
- Grooveless retainer design for ease of cleaning
- Choice of brackets
- Can be installed to curved walls (min 1 m radius)

Applications

- Hospitals, care homes, schools, and other buildings where handrail support may be required
- Corridors

Colours & Texture



Solid Colours
15



Texture
Shadowgrain

See reverse for details.



c-sgroup.eu/374

HR-6N

Mounting Options

Stainless steel brackets

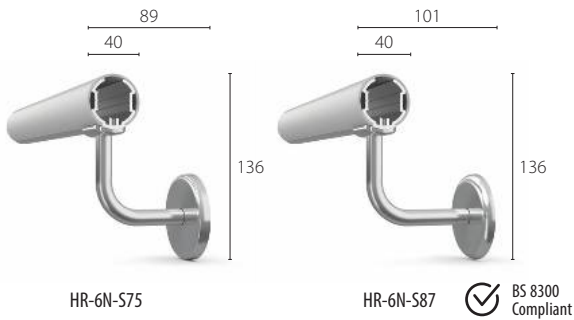

Accessories

- End caps
- External and internal corners
- Stainless steel brackets
- Optional clear collars for end caps and corner pieces

Stock Lengths & Fixings

- Stock lengths: 3 m
- Brackets at max 800 mm centres; fixing into studwork or pattresses is recommended

Warranty & Lifespan

- 2-year product warranty
- Up to 25-year life expectancy

For Terms and Conditions visit: c-sgroup.eu/16727

Colour Selector

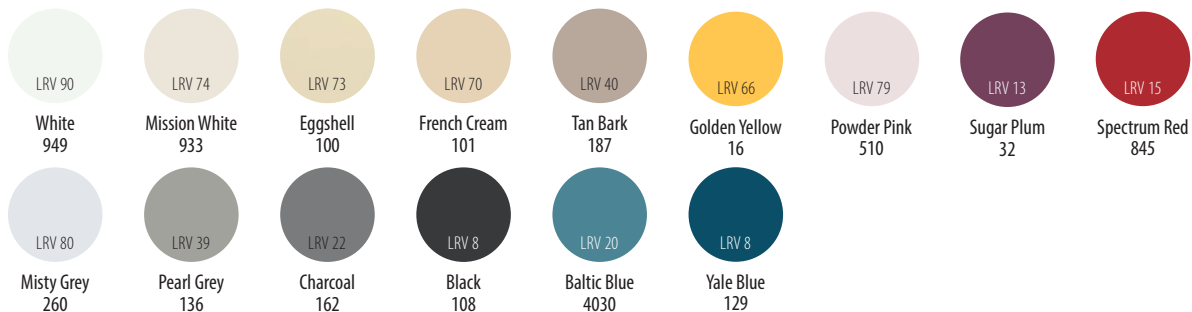

LRV (Light Reflectance Value) indicates the amount of light reflected by a surface and can be used to assess the degree of visual contrast between different surfaces. LRV values for Acrovyn colours have been determined using the CIE Y value measurement method.

HRO-6N



38 mm wide, ergonomically designed oval handrails providing firm support in circulation corridors.



Medium Duty

Features & Advantages

- Comfortable grip, 38 mm wide, oval handrail
- Durable, textured Acrovyn PVC-Free cover available in a range of colours
- Continuous aluminium retainer for sturdy support
- Infill strip closes off retainer groove for ease of cleaning
- Choice of bracket options

Applications

- Hospitals, care homes, schools, and other buildings where handrail support may be required
- Corridors

Colours & Texture



Solid Colours
15



Texture
Shadowgrain

See reverse for details.



c-sgroup.eu/6847

HRO-6N

Mounting Options

Aluminium brackets



HRO-6N-A80

Stainless steel brackets

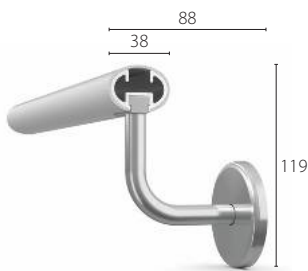

HRO-6N-S75

Accessories

- End caps
- External and internal corners
- End stops in black or grey
- Stainless steel or aluminium brackets
- Optional vertical accent trims - black (standard) or light grey
- Removable kit for service ducts

Stock Lengths & Fixings

- Stock lengths: 3 m
- Brackets at max 800 mm centres; fixing into studwork or pattresses is recommended

Warranty & Lifespan

- 2-year product warranty
- Up to 25-year life expectancy

For Terms and Conditions visit: c-sgroup.eu/16727

Colour Selector

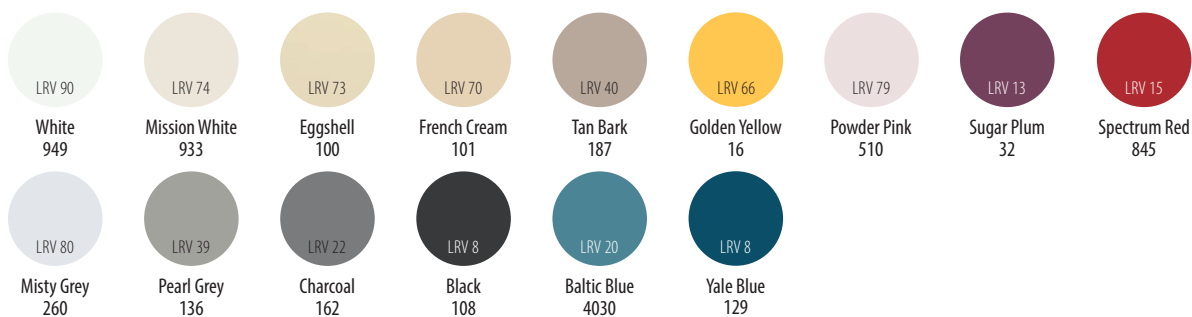

LRV (Light Reflectance Value) indicates the amount of light reflected by a surface and can be used to assess the degree of visual contrast between different surfaces. LRV values for Acrovyn colours have been determined using the CIE Y value measurement method.

HRW-6



40 mm solid timber handrails combining a luxury feel and natural look with comfortable mobility support.



Medium Duty

Features & Advantages

- Sustainably sourced, 40 mm Ø solid timber handrail
- Choice of end caps (timber or stainless steel), rounded timber end stops or rounded integral rail ends
- Untreated timber for finishing on site as standard, or can be supplied in custom sizes in a selection of varnish options upon request
- Choice of brackets
- Can be installed to curved walls (min 800 mm radius)

Applications

- Hospitals, care homes, schools, and other buildings where handrail support may be required
- Corridors

Materials & Finishes



Timber
3 species

All our timber comes from sustainable sources and carries FSC or PEFC certification.



Untreated or
Varnished

Untreated timber as standard. Custom size, ready-to-install handrail kits are available varnished on request.

See reverse for details.



c-sgroup.eu/381

HRW-6

Mounting Options

Stainless steel brackets

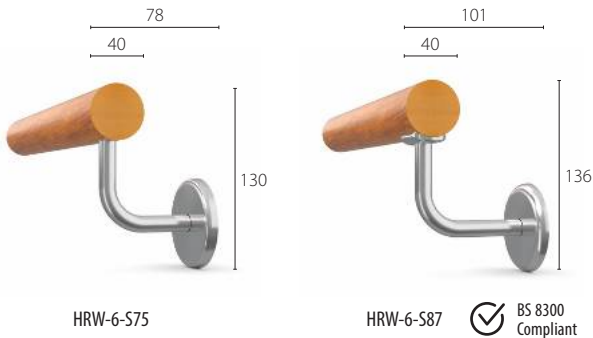

Accessories

- Stainless steel or timber end caps
- Rounded timber end stops (untreated); rounded integral rail ends also available for handrail kits
- Stainless steel or timber internal and external corners
- Stainless steel brackets



Stock Lengths & Fixings













- Lengths: vary depending on timber species and availability
- Brackets at max 800 mm centres; fixing into studwork or pattresses is recommended

Warranty

- 2-year product warranty
- For Terms and Conditions visit: c-sgroup.eu/16727

Material & Finish Selector

Timber Species: Finish Options:

	Standard		Custom size handrail kits	
Oak:				
	Untreated	Natural Varnish	Golden Varnish	Walnut Varnish
Beech:				
	Untreated	Natural Varnish	Golden Varnish	Walnut Varnish
Maple:				
	Untreated	Natural Varnish	Golden Varnish	Walnut Varnish

HRS-6



40 mm, highly durable, stainless steel handrails offering a sleek and modern aesthetic in hygiene sensitive areas.



Medium Duty

Features & Advantages

- Comfortable grip, 40 mm Ø stainless steel handrail
- Supplied prefabricated to surveyed lengths with welded end caps for seamless look and ease of installation
- Choice of brackets
- Easy to clean and maintain solution for hygienic environments
- Can be installed to curved walls (min 500 mm radius)

Applications

- Corridors in buildings where handrail support may be required

Material & Finish



Stainless Steel
Grade 304L



Finish
Brushed



c-sgroup.eu/376

HRS-6

Mounting Options

Stainless steel brackets

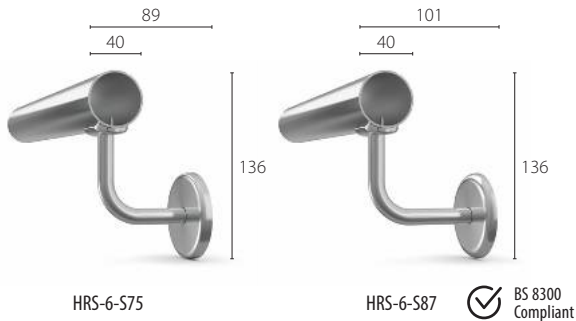

Accessories

- Stainless steel end caps
- Stainless steel internal and external corners
- Stainless steel brackets

Stock Lengths & Fixings

- Lengths to cutting schedule from stock lengths of max 3 m
- Brackets at max 800 mm centres; fixing into studwork or pattresses is recommended

Warranty & Lifespan

- 2-year product warranty
- Life expectancy over 25 years

For Terms and Conditions visit: [c-sgroup.eu/16727](https://www.c-sgroup.eu/16727)



HRA-6



40 mm circular, anodised aluminium handrails offering durable and comfortable mobility support.



Medium Duty

Features & Advantages

- 40 mm Ø anodised aluminium handrail
- Infill strip closes off retainer groove for ease of cleaning
- Choice of brackets
- Can be installed to curved walls (min 1 m radius)

Applications

- Corridors in buildings where handrail support may be required
- Staircases

Material & Finish



Material
Aluminium



Finish
Clear anodised



c-sgroup.eu/6855

HRA-6

Mounting Options

Aluminium brackets

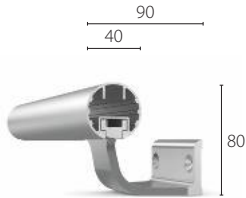

HRA-6-A80

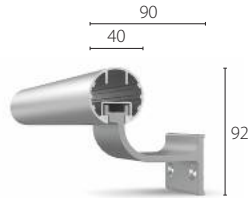

HRA-6-A60

Stainless steel brackets

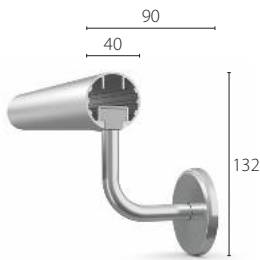

HRA-6-S75

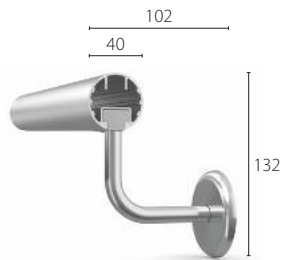

HRA-6-S87



Accessories

- End caps
- External, internal and odd angle corners (120° to 165°)
- Stainless steel or aluminium brackets (including option for radiused installations)
- Optional vertical accent trims - black (standard) or light grey
- Removable kit for service ducts

Stock Lengths & Fixings

- Stock lengths: 4 m
- Brackets at max 800 mm centres; fixing into studwork or pattresses is recommended

Warranty & Lifespan

- 2-year product warranty
- Life expectancy over 25 years

For Terms and Conditions visit: c-sgroup.eu/16727



Acrovyn[®]
Hand/Crash Rails



HRB-20

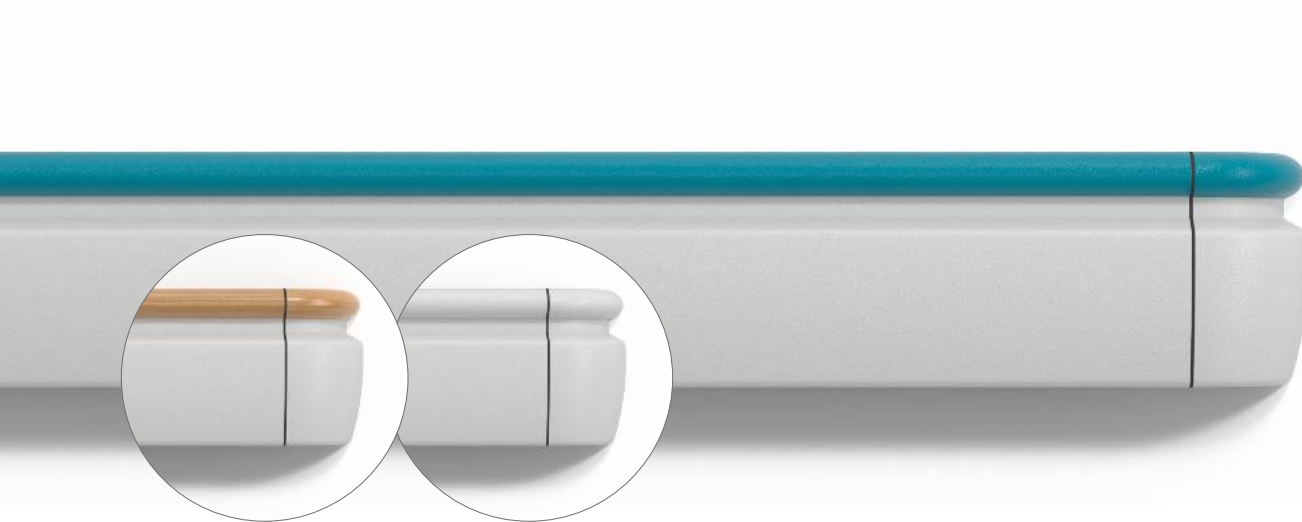

143 mm high, Acrovyn hand/crash rails offering pedestrian support and heavy duty impact protection. Two colours can be used to provide visual contrast.



Quick Lock



Heavy Duty



Dual Colour

Features & Advantages

- Comfortable, oval grip handrail available in solid colours and decorative finishes
- Impact resistant crash rail cover over continuous aluminium retainer and bumper cushion for effective damage protection
- Two colours can be used for visual contrast or in wayfinding schemes
- Quick Lock brackets for fast installation and easy maintenance
- Infill strip closes off retainer channel for ease of cleaning
- Anti-ligature option featuring continuous, powder coated aluminium bracket

Applications

- Corridors with pedestrian access and regular trolley movement
- Lift lobbies and lifts
- Circulation areas with anti-ligature handrail requirements

Colours & Texture

Solid Colours
27Finishes (Handrail Only)
12Texture
Shadowgrain

See reverse for details.



c-sgroup.eu/134

HRB-20

Mounting Options

Quick Lock bracket

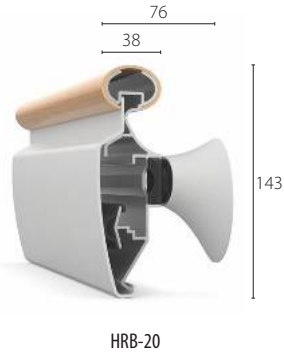

HRB-20

Quick Lock brackets are supplied in a colour matching crash rail cover as standard.

Anti-ligature bracket

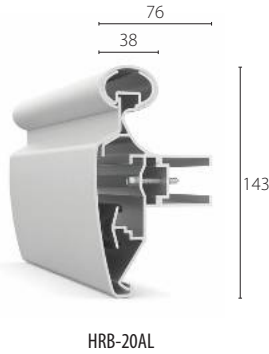

HRB-20AL

Continuous aluminium brackets are supplied powder coated grey (RAL 7046) as standard.

Accessories

- End caps with Quick Lock feature
- External corners
- Quick Lock brackets (standard)
- Continuous anti-ligature brackets (optional)
- Optional vertical accent trims - black
- Removable kit for service ducts

Stock Lengths & Fixings

- Stock lengths: 4 m
- Brackets at max 800 mm centres; fixing into studwork or pattresses is recommended

Warranty & Lifespan

- 2-year product warranty
- Up to 25-year life expectancy

For Terms and Conditions visit: c-sgroup.eu/16727

Colour Selector

Solid Colours										
Finishes (handrail only)										

LRV (Light Reflectance Value) indicates the amount of light reflected by a surface and can be used to assess the degree of visual contrast between different surfaces. LRV values for Acrovyn colours have been determined using the CIE Y value measurement method.

HRB-4C



140 mm high hand/crash rails, in a classic flat profile, offering severe duty impact protection and mobility support in circulation routes.



Quick Lock



Severe Duty

Features & Advantages

- Comfortable grip handrail top
- Free-floating Acrovyn cover flexes on impact, neutralising its force
- Continuous shock-absorbing cushion for increased impact protection
- Quick Lock brackets for fast installation and easy maintenance
- Infill strip closes off retainer channel for ease of cleaning
- Anti-ligature option featuring continuous, powder coated aluminium bracket

Applications

- Corridors with pedestrian access and regular trolley movement
- Lift lobbies and lifts
- Circulation areas with anti-ligature handrail requirements

Colours & Texture



Solid Colours
27



Texture
Shadowgrain

See reverse for details.



c-sgroup.eu/371

HRB-4C

Mounting Options

Quick Lock bracket

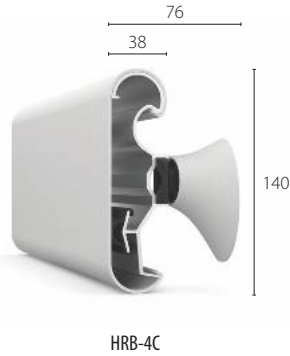

HRB-4C

Quick Lock brackets are supplied in a colour matching cover as standard.

Anti-ligature bracket

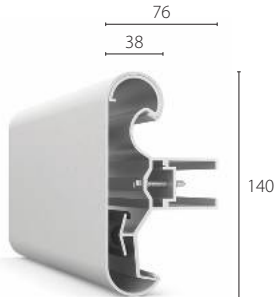

HRB-4CAL

Continuous aluminium brackets are supplied powder coated grey (RAL 7046) as standard.

Accessories

- End caps
- External corners
- Quick Lock brackets (standard)
- Continuous anti-ligature brackets (optional)
- Optional vertical accent trims - black
- Removable kit for service ducts

Stock Lengths & Fixings

- Stock lengths: 4 m
- Brackets at max 800 mm centres; fixing into studwork or pattresses is recommended

Warranty & Lifespan

- 2-year product warranty
- Up to 25-year life expectancy

For Terms and Conditions visit: c-sgroup.eu/16727

Colour Selector

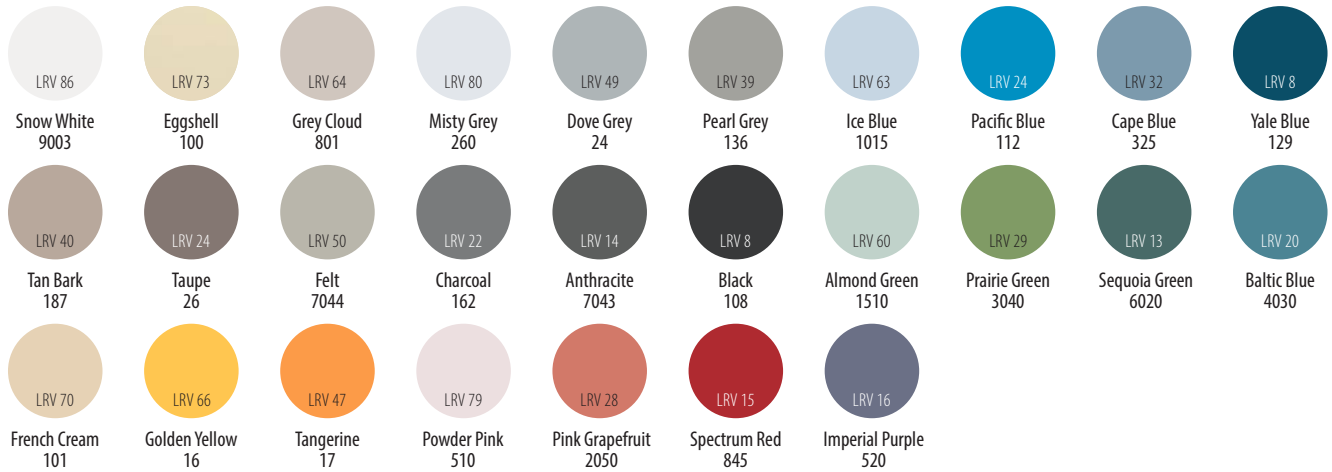

LRV (Light Reflectance Value) indicates the amount of light reflected by a surface and can be used to assess the degree of visual contrast between different surfaces. LRV values for Acrovyn colours have been determined using the CIE Y value measurement method.

HRB-35



89 mm high, Acrovyn hand/crash rails in a stylish curved design offering comfortable grip and heavy duty protection with minimum visual impact.



Quick Lock



Heavy Duty

Features & Advantages

- Comfortable grip handrail top
- Free-floating, curved-design cover flexes on impact, neutralising its force
- Optional vertical accent trim at the joint between the end cap and the cover
- Quick Lock brackets for fast installation and easy maintenance
- Infill strip closes off retainer channel for ease of cleaning

Applications

- Corridors with pedestrian access and regular trolley movement
- Lift lobbies and lifts

Colours & Texture



Solid Colours
27



Texture
Shadowgrain

See reverse for details.



c-sgroup.eu/6865

HRB-35

Mounting

Quick Lock brackets

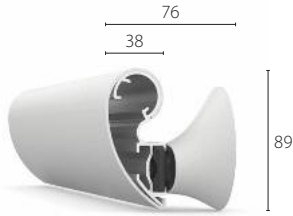

HRB-35

Brackets are supplied in a colour matching cover as standard.

Accessories

- End caps with Quick Lock feature
- External corners
- Quick Lock brackets
- Optional vertical accent trims - black
- Removable kit for service ducts

Stock Lengths & Fixings

- Stock lengths: 4 m
- Brackets at max 800 mm centres; fixing into studwork or pattresses is recommended

Warranty & Lifespan

- 2-year product warranty
- Up to 25-year life expectancy

For Terms and Conditions visit: c-sgroup.eu/16727

Colour Selector

LRV (Light Reflectance Value) indicates the amount of light reflected by a surface and can be used to assess the degree of visual contrast between different surfaces. LRV values for Acrovyn colours have been determined using the CIE Y value measurement method.

HRB-20N

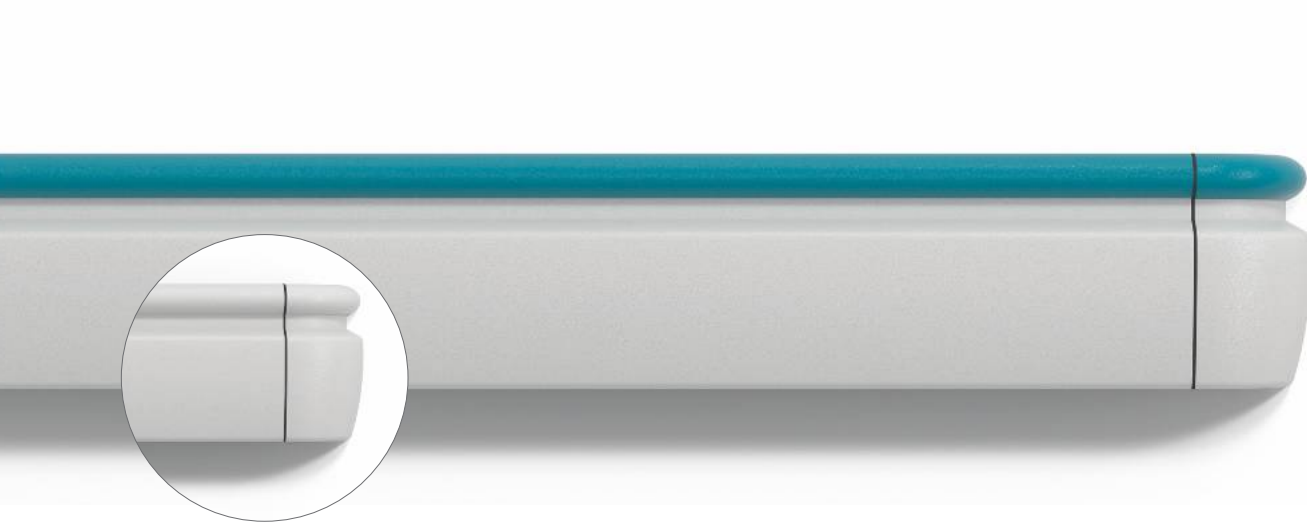

143 mm high, Acrovyn PVC-Free hand/crash rails offering pedestrian support and heavy duty impact protection. Two colours can be used to provide visual contrast.



Quick Lock



Heavy Duty



Dual Colour

Features & Advantages

- Comfortable, oval grip handrail available in a range of solid colours
- Impact resistant crash rail cover over continuous aluminium retainer and bumper cushion for effective damage protection
- Two colours can be used for visual contrast or in wayfinding schemes
- Quick Lock brackets for fast installation and easy maintenance
- Infill strip closes off retainer channel for ease of cleaning
- Anti-ligature option featuring continuous, powder coated aluminium bracket

Applications

- Corridors with pedestrian access and regular trolley movement
- Lift lobbies and lifts
- Circulation areas with anti-ligature handrail requirements

Colours & Texture

Solid Colours
15Texture
Shadowgrain

See reverse for details.



c-sgroup.eu/134

HRB-20N

Mounting Options

Quick Lock bracket

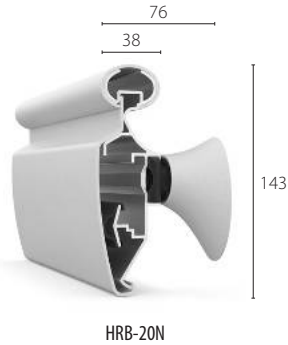

HRB-20N

Quick Lock brackets are supplied in a colour matching crash rail cover as standard.

Anti-ligature bracket

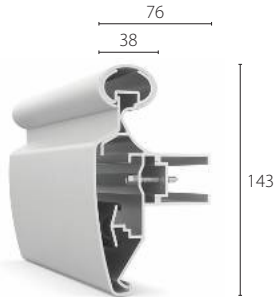

HRB-20ALN

Continuous aluminium brackets are supplied powder coated grey (RAL 7046) as standard.

Accessories

- End caps with Quick Lock feature
- External corners
- Quick Lock brackets (standard)
- Continuous anti-ligature brackets (optional)
- Optional vertical accent trims - black
- Removable kit for service ducts

Stock Lengths & Fixings

- Stock lengths: 3 m
- Brackets at max 800 mm centres; fixing into studwork or pattresses is recommended

Warranty & Lifespan

- 2-year product warranty
- Up to 25-year life expectancy

For Terms and Conditions visit: c-sgroup.eu/16727

Colour Selector

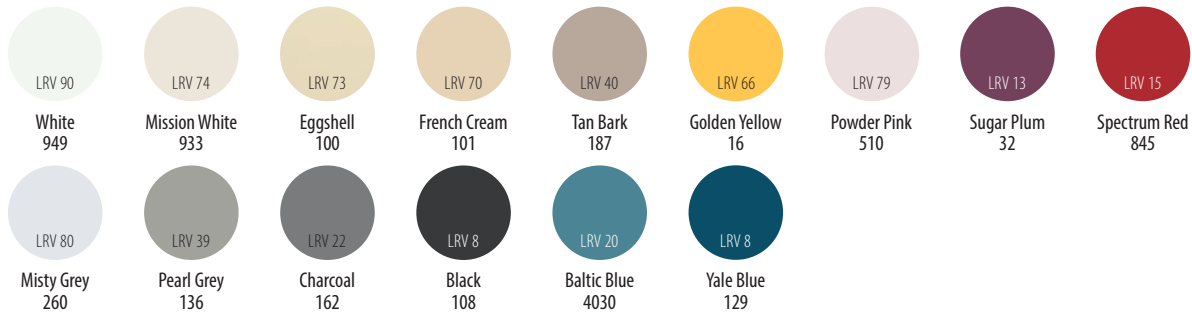

LRV (Light Reflectance Value) indicates the amount of light reflected by a surface and can be used to assess the degree of visual contrast between different surfaces. LRV values for Acrovyn colours have been determined using the CIE Y value measurement method.

HRB-4CN



140 mm high hand/crash rails, in a classic flat profile, offering severe duty impact protection and mobility support in circulation routes.



Quick Lock



Severe Duty

Features & Advantages

- Comfortable grip handrail top
- Free-floating Acrovyn PVC-Free cover flexes on impact, neutralising its force
- Continuous shock-absorbing cushion for increased impact protection
- Quick Lock brackets for fast installation and easy maintenance
- Infill strip closes off retainer channel for ease of cleaning
- Anti-ligature option featuring continuous, powder coated aluminium bracket

Applications

- Corridors with pedestrian access and regular trolley movement
- Lift lobbies and lifts
- Circulation areas with anti-ligature handrail requirements

Colours & Texture



Solid Colours
15



Texture
Shadowgrain

See reverse for details.



c-sgroup.eu/371

HRB-4CN

Mounting Options

Quick Lock bracket

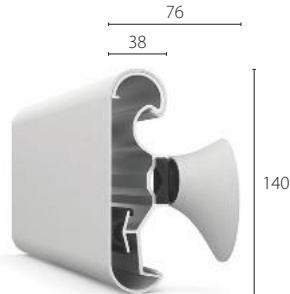

HRB-4CN

Quick Lock brackets are supplied in a colour matching cover as standard.

Anti-ligature bracket

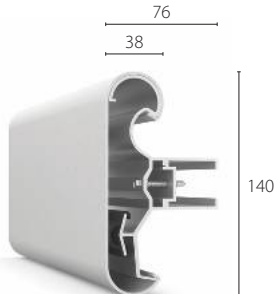

HRB-4CALN

Continuous aluminium brackets are supplied powder coated grey (RAL 7046) as standard.

Accessories

- End caps
- External corners
- Quick Lock brackets (standard)
- Continuous anti-ligature brackets (optional)
- Optional vertical accent trims - black
- Removable kit for service ducts

Stock Lengths & Fixings

- Stock lengths: 3 m
- Brackets at max. 800 mm centres; fixing into studwork or pattresses is recommended

Warranty & Lifespan

- 2-year product warranty
- Up to 25-year life expectancy

For Terms and Conditions visit: c-sgroup.eu/16727

Colour Selector

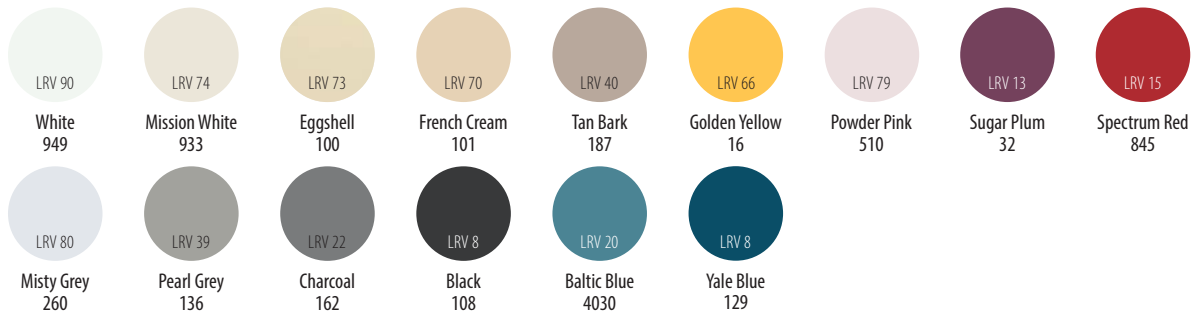

LRV (Light Reflectance Value) indicates the amount of light reflected by a surface and can be used to assess the degree of visual contrast between different surfaces. LRV values for Acrovyn colours have been determined using the CIE Y value measurement method.

HRB-35N



89 mm high, Acrovyn PVC-Free hand/crash rails in a stylish curved design offering comfortable grip and heavy duty protection with minimum visual impact.



Quick Lock



Heavy Duty

Features & Advantages

- Comfortable grip handrail top
- Free-floating, curved-design cover flexes on impact, neutralising its force
- Optional vertical accent trim at the joint between the end cap and the cover
- Quick Lock brackets for fast installation and easy maintenance
- Infill strip closes off retainer channel for ease of cleaning

Applications

- Corridors with pedestrian access and regular trolley movement
- Lift lobbies and lifts

Colours & Texture



Solid Colours
15



Texture
Shadowgrain

See reverse for details.



c-sgroup.eu/6865

HRB-35N

Mounting

Quick Lock brackets

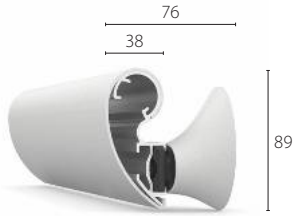

HRB-35N

Brackets are supplied in a colour matching cover as standard.

Accessories

- End caps with Quick Lock feature
- External corners
- Quick Lock brackets
- Optional vertical accent trims - black
- Removable kit for service ducts

Stock Lengths & Fixings

- Stock lengths: 3 m
- Brackets at max 800 mm centres; fixing into studwork or pattresses is recommended

Warranty & Lifespan

- 2-year product warranty
- Up to 25-year life expectancy

For Terms and Conditions visit: c-sgroup.eu/16727

Colour Selector

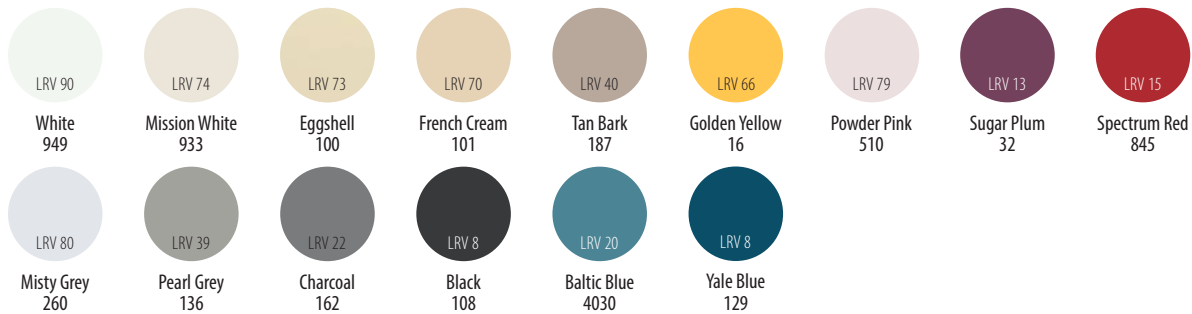

LRV (Light Reflectance Value) indicates the amount of light reflected by a surface and can be used to assess the degree of visual contrast between different surfaces. LRV values for Acrovyn colours have been determined using the CIE Y value measurement method.

HRB-50N

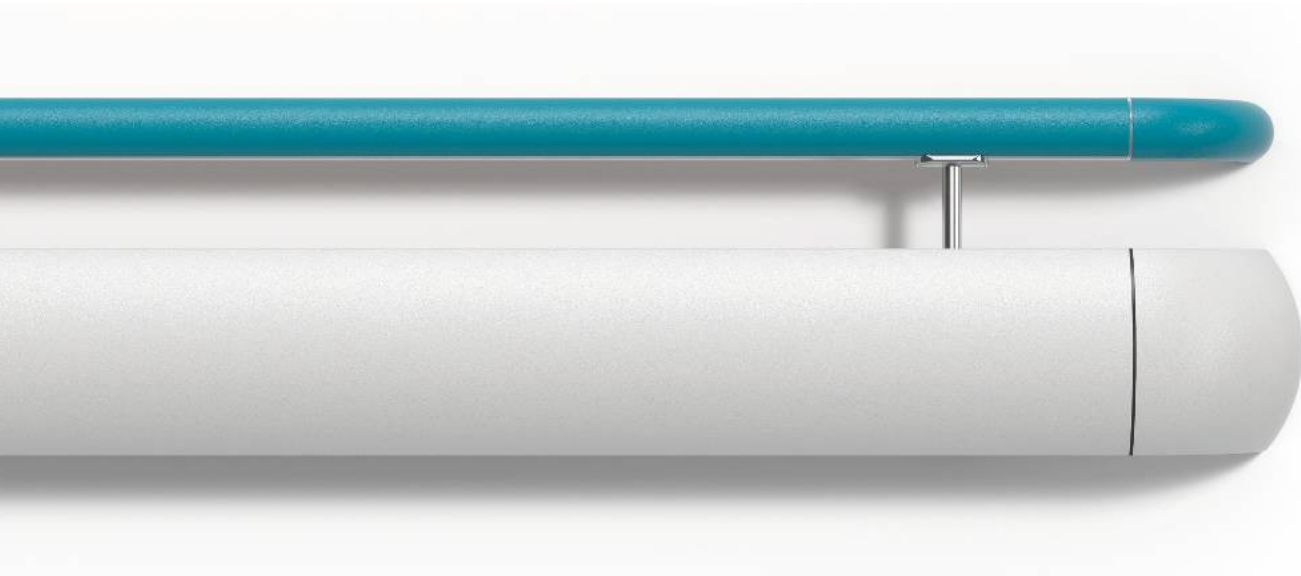

220 mm high, HRB-50N combines a PVC-Free handrail and crash rail on a stainless steel bracket, to provide mobility support and impact protection.



Heavy Duty



Dual Colour

Features & Advantages

- BS 8300 compliant hand/crash rail for busy circulation areas
- 40 mm Ø handrail with textured cover over aluminium retainer, for secure and comfortable grip
- 127 mm high crash rail with curved cover over continuous aluminium retainer and shock-absorbing cushion, for effective impact protection
- Matching or contrasting colours can be selected to suit project requirements
- Infill strip closes off crash rail's retainer channel for ease of cleaning
- Mounted on robust stainless steel brackets

Applications

- Corridors with pedestrian access and regular trolley movement
- Lift lobbies and lifts

Colours & Texture



Solid Colours
15



Texture
Shadowgrain

See reverse for details.



c-sgroup.eu/369

HRB-50N

Mounting

Stainless steel brackets

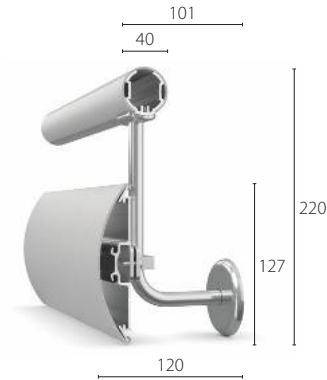

HRB-50N  BS 8300
Compliant

Accessories

- End caps
- External corners
- Internal corners available for handrail
- Stainless steel brackets
- Optional vertical accent trims / collars: handrail - clear; crash rail - black

Stock Lengths & Fixings

- Stock lengths: 3 m
- Brackets at max 800 mm centres; fixing into studwork or pattresses is recommended

Warranty & Lifespan

- 2-year product warranty
- Life expectancy up to 25 years

For Terms and Conditions visit: c-sgroup.eu/16727

Colour Selector

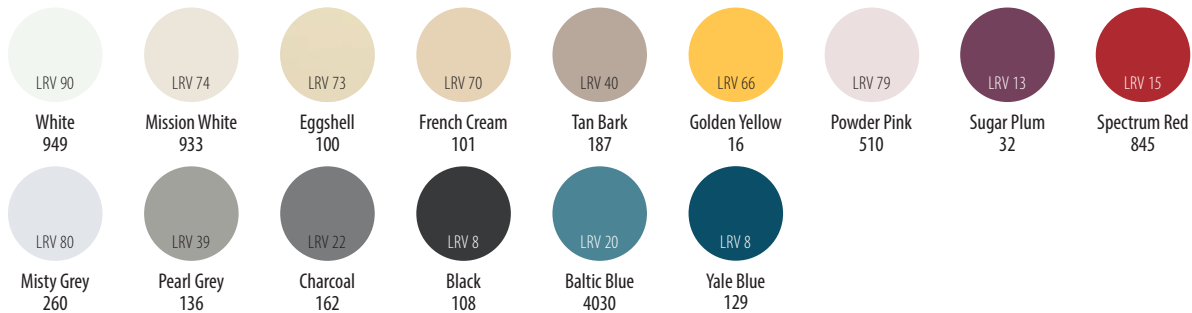

LRV (Light Reflectance Value) indicates the amount of light reflected by a surface and can be used to assess the degree of visual contrast between different surfaces. LRV values for Acrovyn colours have been determined using the CIE Y value measurement method.

HRBW-50N



220 mm high, HRBW-50N combines a solid timber handrail and a PVC-Free crash rail on a stainless steel bracket, to provide mobility support and impact protection.



Heavy Duty



Dual Colour

Features & Advantages

- Stylish, BS 8300 compliant hand/crash rails for busy circulation areas
- 40 mm Ø solid timber handrail with stainless steel accessories, for secure and comfortable grip
- 127 mm high crash rail with curved cover over continuous aluminium retainer and shock-absorbing cushion, for effective impact protection
- Infill strip closes off crash rail's retainer channel for ease of cleaning
- Mounted on robust stainless steel brackets

Applications

- Corridors with pedestrian access and regular trolley movement
- Lift lobbies and lifts

Colours & Texture

Handrail:



Timber
3 species



Untreated or
Varnished

Crash Rail:



Solid Colours
15



Texture
Shadowgrain

Our timber comes from sustainable sources and carries FSC or PEFC certification. Handrails are untreated as standard, varnished handrail kits are available.

See reverse for details.



c-sgroup.eu/16725

HRBW-50N

Mounting

Stainless steel brackets

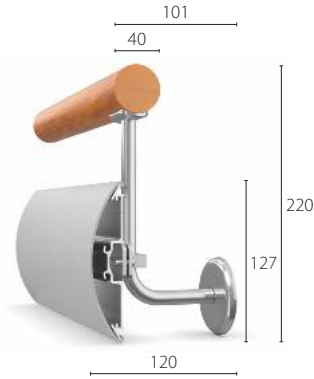

HRBW-50N BS 8300 Compliant

Accessories

- Handrail: stainless steel end caps, internal and external corners
- Crash rail: end caps and external corners
- Stainless steel brackets
- Optional vertical accent trims for crash rail - black

Stock Lengths & Fixings

- Handrail: stock lengths vary, depending on timber species and availability
- Crash rail - 3 m
- Brackets at max 800 mm centres; fixing into studwork or pattresses is recommended

Warranty & Lifespan

- 2-year product warranty
- Life expectancy up to 25 years

For Terms and Conditions visit: c-sgroup.eu/16727

Colour & Finish Selector

	Timber species	Standard finish	Custom size handrail kits - varnish options							
Timber handrail	Oak	Untreated	Natural Varnish	Golden Varnish	Walnut Varnish					
	Beech	Untreated	Natural Varnish	Golden Varnish	Walnut Varnish					
	Maple	Untreated	Natural Varnish	Golden Varnish	Walnut Varnish					
Crash rail		LRV 90 White 949	LRV 74 Mission White 933	LRV 73 Eggshell 100	LRV 70 French Cream 101	LRV 40 Tan Bark 187	LRV 66 Golden Yellow 16	LRV 79 Powder Pink 510	LRV 13 Sugar Plum 32	LRV 15 Spectrum Red 845
		LRV 80 Misty Grey 260	LRV 39 Pearl Grey 136	LRV 22 Charcoal 162	LRV 8 Black 108	LRV 20 Baltic Blue 4030	LRV 8 Yale Blue 129			
	<p>LRV (Light Reflectance Value) indicates the amount of light reflected by a surface and can be used to assess the degree of visual contrast between different surfaces. LRV values for Acrovyn colours have been determined using the CIE Y value measurement method.</p>									

Acrovyn®
Crash Rails



SCR-80

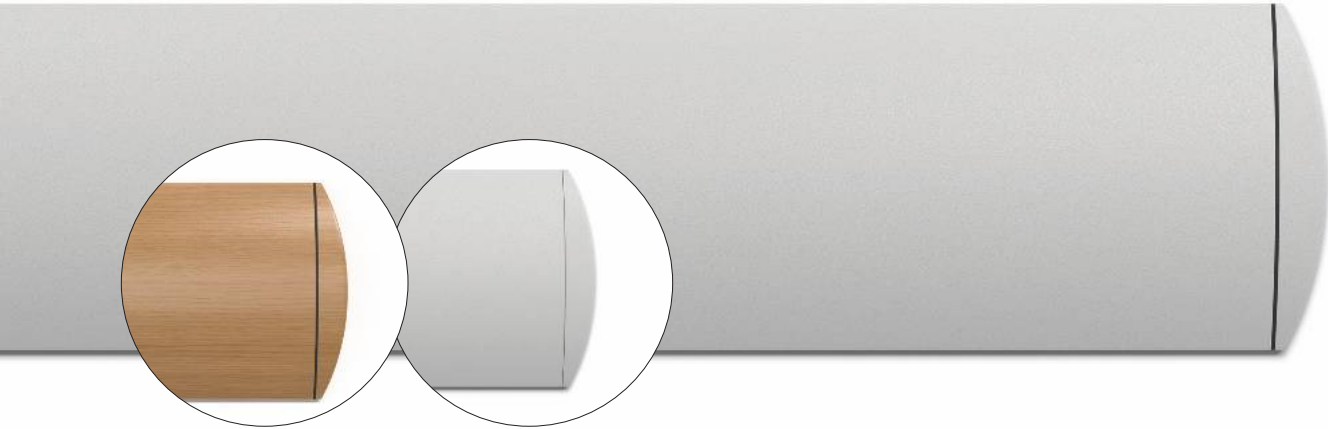

203 mm high, curved-profile crash rails offering a modern aesthetic and extensive impact protection in high traffic areas.



Heavy / Medium
Duty

Features & Advantages

- Impact resistant, textured Acrovyn cover over continuous aluminium retainer as standard
- A version mounted on aluminium clips for areas requiring medium duty protection
- Free-floating cover and internal, continuous bumper cushion effectively absorb impact force
- Covers are easy to replace

Applications

- Corridors with frequent trolley or bed movement
- Production areas and laboratories
- Back of house areas in retail facilities and hotels
- Lift areas and lifts

Colours & Texture



Solid Colours
27



Finishes
12



Texture
Shadowgrain

See reverse for details.



c-sgroup.eu/384

SCR-80

Surface Mounted

Continuous retainer
Heavy Duty

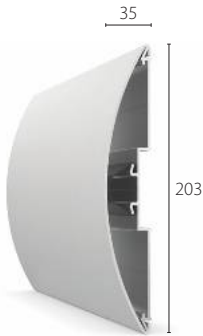

SCR-80M

Mounting clips
Medium Duty

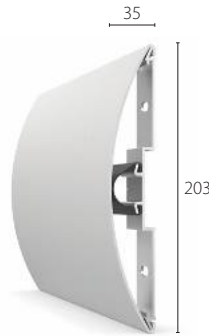

SCR-80

Accessories

- End caps
- External corners
- Optional vertical accent trims - black (standard) or light grey

Stock Lengths & Fixings

- Stock lengths: 4 m
- Fix at max 600 mm centres; aluminium clips at max 600 mm centres.

Warranty & Lifespan

- 2-year product warranty
- Up to 25-year life expectancy

For Terms and Conditions visit: c-sgroup.eu/16727

Colour Selector

Solid Colours										
Finishes										
								<p><i>LRV (Light Reflectance Value) indicates the amount of light reflected by a surface and can be used to assess the degree of visual contrast between different surfaces. LRV values for Acrovyn colours have been determined using the CIE Y value measurement method.</i></p>		

SCR-50



127 mm high, curved-profile crash rails offering reliable protection in areas prone to impact damage.



Heavy / Medium
Duty

Features & Advantages

- Impact resistant, textured Acrovyn cover over continuous aluminium retainer as standard
- A version mounted on aluminium clips for areas requiring medium duty protection
- Free-floating cover and internal, continuous bumper cushion effectively absorb impact force
- Covers are easy to replace

Applications

- Corridors with frequent trolley or bed movement
- Production areas and laboratories
- Back of house areas in retail facilities and hotels
- Lift areas and lifts

Colours & Texture



Solid Colours
27



Texture
Shadowgrain

See reverse for details.



c-sgroup.eu/387

SCR-50

Surface Mounted

Continuous retainer
Heavy Duty

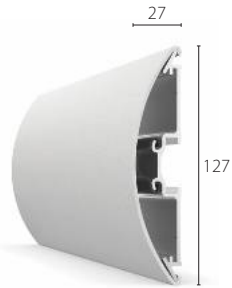

SCR-50M

Mounting clips
Medium Duty

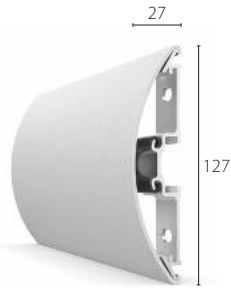

SCR-50

Accessories

- End caps
- External corners
- Optional vertical accent trims - black

Stock Lengths & Fixings

- Stock lengths: 4 m
- Fix at max 600 mm centres; aluminium clips at max 600 mm centres.

Warranty & Lifespan

- 2-year product warranty
- Up to 25-year life expectancy

For Terms and Conditions visit: c-sgroup.eu/16727

Colour Selector

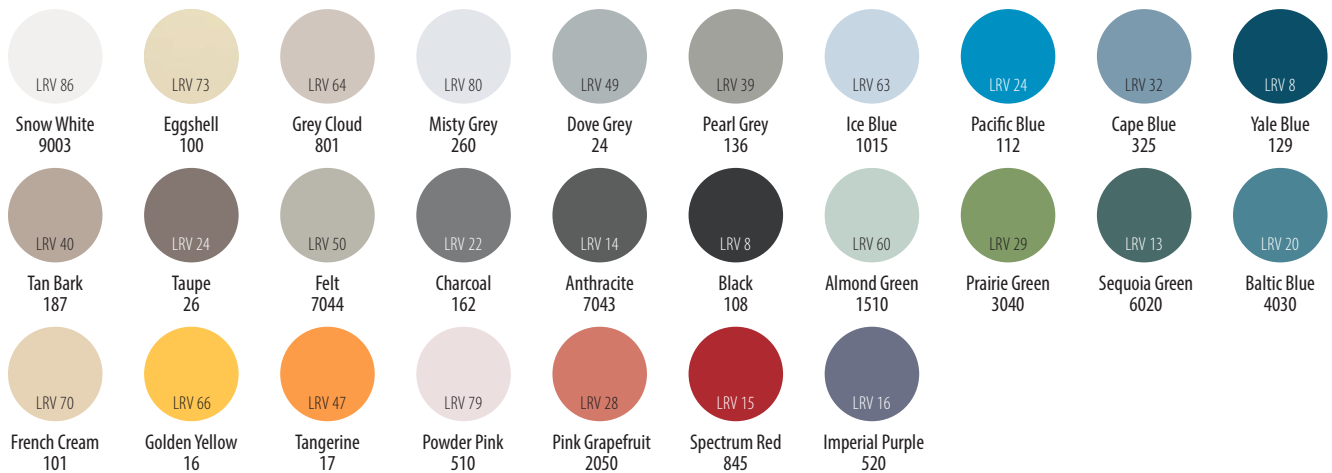

LRV (Light Reflectance Value) indicates the amount of light reflected by a surface and can be used to assess the degree of visual contrast between different surfaces. LRV values for Acrovyn colours have been determined using the CIE Y value measurement method.

SCR-170

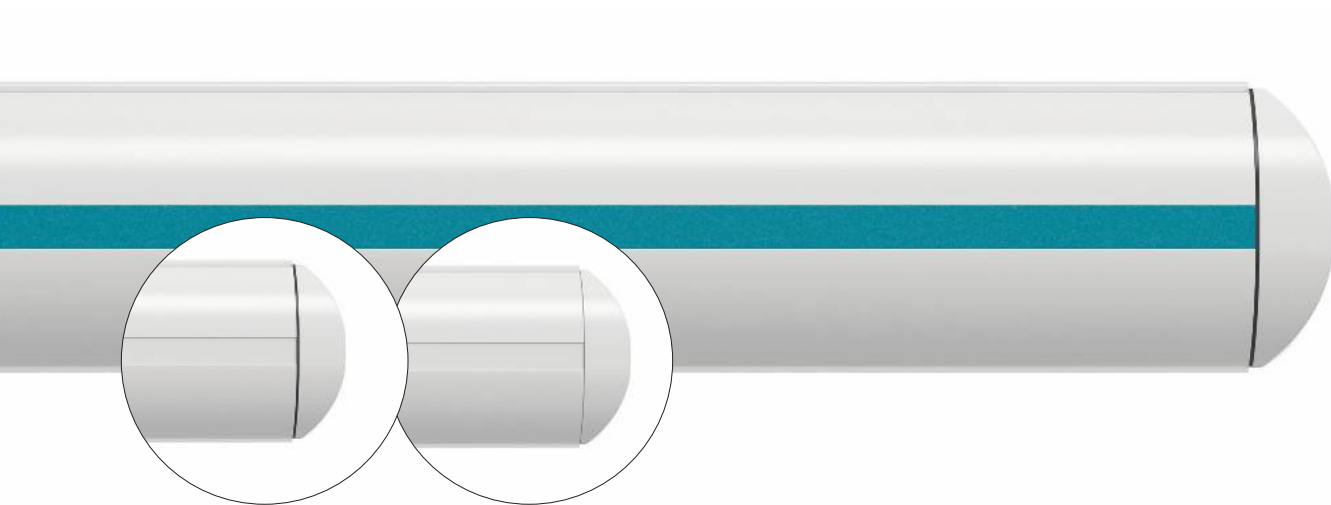

170mm high, curved-profile crash rails with smooth cover, offering essential impact protection in hygiene sensitive areas.



Heavy / Medium
Duty



Dual Colour

Features & Advantages

- Impact resistant, smooth Acrovyn cover over continuous bumper cushion and aluminium mounting clips as standard
- A version with cover over aluminium clips for areas requiring medium duty protection
- Flexible top and bottom edge seals for a hygienic finish
- Optional insert in a contrasting colour can be used to add style or create wayfinding schemes
- Covers are easy to replace

Applications

- Corridors with frequent trolley or bed movement
- Production areas and laboratories
- Back of house areas in retail facilities and hotels
- Lift areas and lifts

Colours & Texture



Solid Colours¹
27



Texture¹
Smooth

See reverse for details.

¹ Optional decorative inserts have Suede texture and are available in 36 colours.



c-sgroup.eu/6867

SCR-170

Surface Mounted

Continuous bumper & mounting clips

Heavy Duty

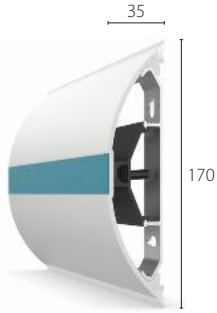

SCR-170

Mounting clips

Medium Duty

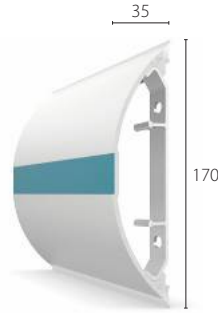

SCR-170E

Accessories

- End caps
- External corners
- Optional vertical accent trims - black
- Optional decorative inserts

Stock Lengths & Fixings

- Stock lengths: 4 m
- Aluminium clips at max 600 mm centres

Warranty & Lifespan

- 2-year product warranty
- Up to 25-year life expectancy

For Terms and Conditions visit: c-sgroup.eu/16727

Colour Selector

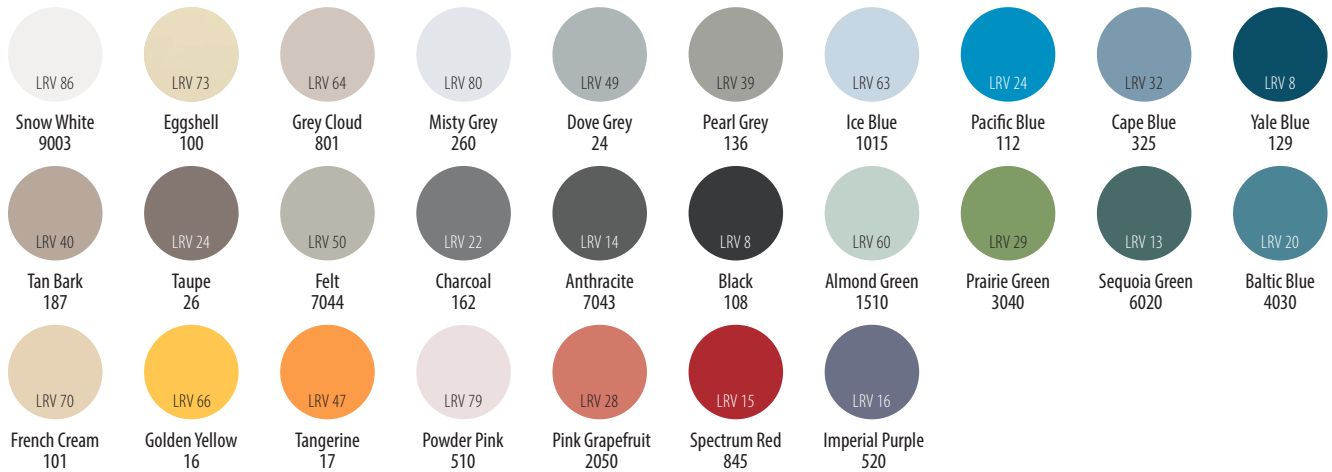

Additional colours for optional decorative inserts:



LRV (Light Reflectance Value) indicates the amount of light reflected by a surface and can be used to assess the degree of visual contrast between different surfaces. LRV values for Acrovyn colours have been determined using the CIE Y value measurement method.

SCR-200



203 mm high, classic flat style crash rails designed to prevent wall damage in busy facilities.



Heavy / Medium
Duty

Features & Advantages

- Impact resistant, textured Acrovyn cover over continuous aluminium retainer as standard
- A version mounted on aluminium clips for areas requiring medium duty protection
- Free-floating cover and two internal, continuous bumper cushions absorb impact force
- Covers are easy to replace

Applications

- Corridors with frequent trolley or bed movement
- Production areas and laboratories
- Back of house areas in retail facilities and hotels
- Lift areas and lifts

Colours & Texture



Solid Colours
27



Texture
Shadowgrain

See reverse for details.



c-sgroup.eu/2524

SCR-200

Surface Mounted

Continuous retainer
Heavy Duty



SCR-200M

Mounting clips
Medium Duty



SCR-200

Accessories

- End caps
- External corners

Stock Lengths & Fixings

- Stock lengths: 4 m
- Fix at max 600 mm centres; aluminium clips at max 600 mm centres.

Warranty & Lifespan

- 2-year product warranty
- Up to 25-year life expectancy

For Terms and Conditions visit: c-sgroup.eu/16727

Colour Selector

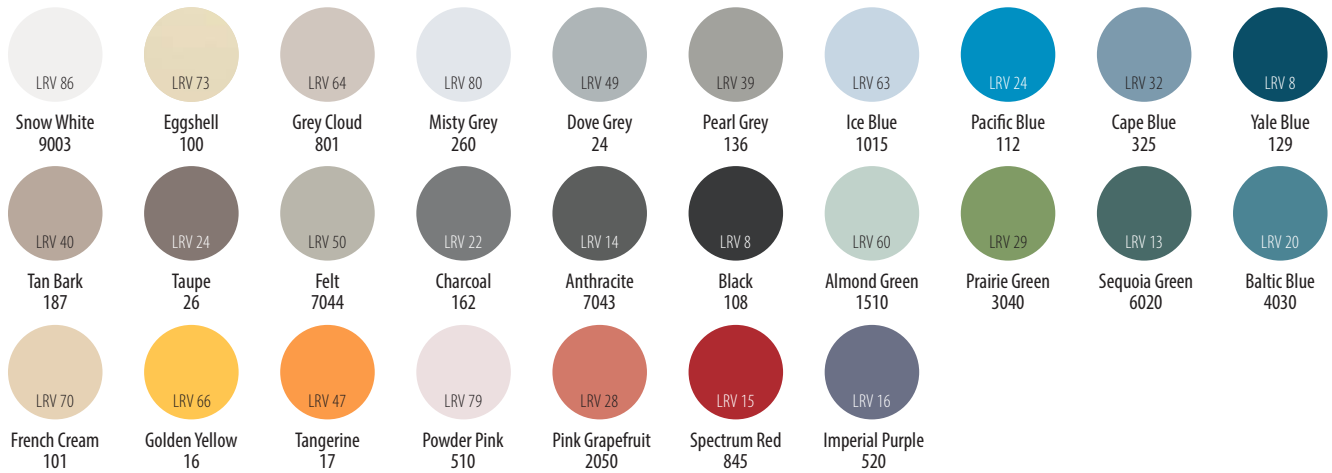

LRV (Light Reflectance Value) indicates the amount of light reflected by a surface and can be used to assess the degree of visual contrast between different surfaces. LRV values for Acrovyn colours have been determined using the CIE Y value measurement method.

HCR-200



Severe Duty



Quick Lock

Features & Advantages

- Impact resistant, textured Acrovyn cover over continuous aluminium retainer
- Free-floating cover design and three internal, continuous bumper cushions absorb impact force
- Mounted on extended Quick Lock brackets for ease of installation and maintenance
- Large stand-off keeps wheeled equipment away from walls
- Return to wall end caps for additional protection

Applications

- Corridors with frequent trolley or bed movement
- Production areas and laboratories
- Back of house areas
- Lift areas and lifts

Colours & Texture

Solid Colours
27Texture
Shadowgrain

See reverse for details.



c-sgroup.eu/2534

HCR-200

Bracket Mounted

Extended Quick Lock brackets

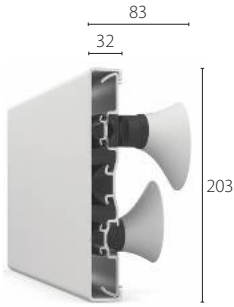

HCR-200

Accessories

- End caps
- External corners
- Extended Quick Lock brackets

Stock Lengths & Fixings

- Stock lengths: 4 m
- Brackets at max 600 mm staggered centres. Fixing into studwork or pattresses recommended.

Warranty & Lifespan

- 2-year product warranty
- Up to 25-year life expectancy

For Terms and Conditions visit: c-sgroup.eu/16727

Colour Selector

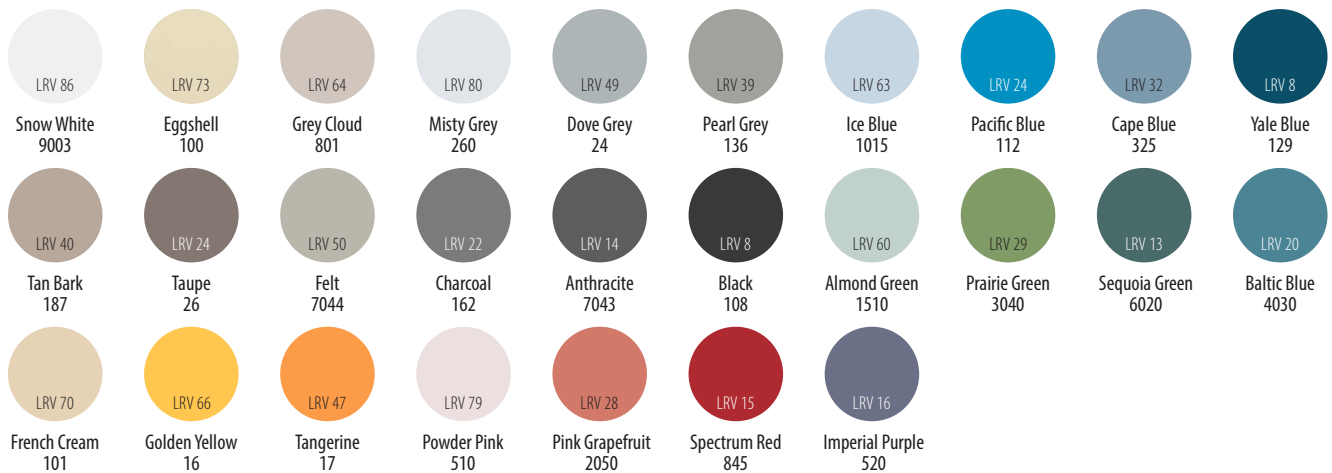

LRV (Light Reflectance Value) indicates the amount of light reflected by a surface and can be used to assess the degree of visual contrast between different surfaces. LRV values for Acrovyn colours have been determined using the CIE Y value measurement method.

BG-10



102 mm high, bullnose style bumper guards designed to keep wheeled equipment away from the wall. Often used at low level, in combination with handrails or other crash rails.



Medium Duty

Features & Advantages

- Textured Acrovyn cover over continuous aluminium retainer
- Large bullnose profile flexes for maximum bumper action protection
- Mounted on spacers for extra stand-off from the wall
- Covers are easy to replace

Applications

- Corridors
- Reception areas
- Back of house areas
- Lift areas and lifts

Colours & Texture



Solid Colours
27



Texture
Shadowgrain

See reverse for details.



c-sgroup.eu/2535

BG-10

Spacer Mounted

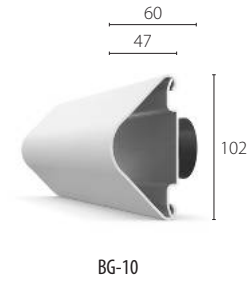

Accessories

- End caps
- External corners

Stock Lengths & Fixings

- Stock lengths: 4 m
- Fix at max 600 mm centres

Warranty & Lifespan

- 2-year product warranty
- Up to 25-year life expectancy

For Terms and Conditions visit: c-sgroup.eu/16727

Colour Selector

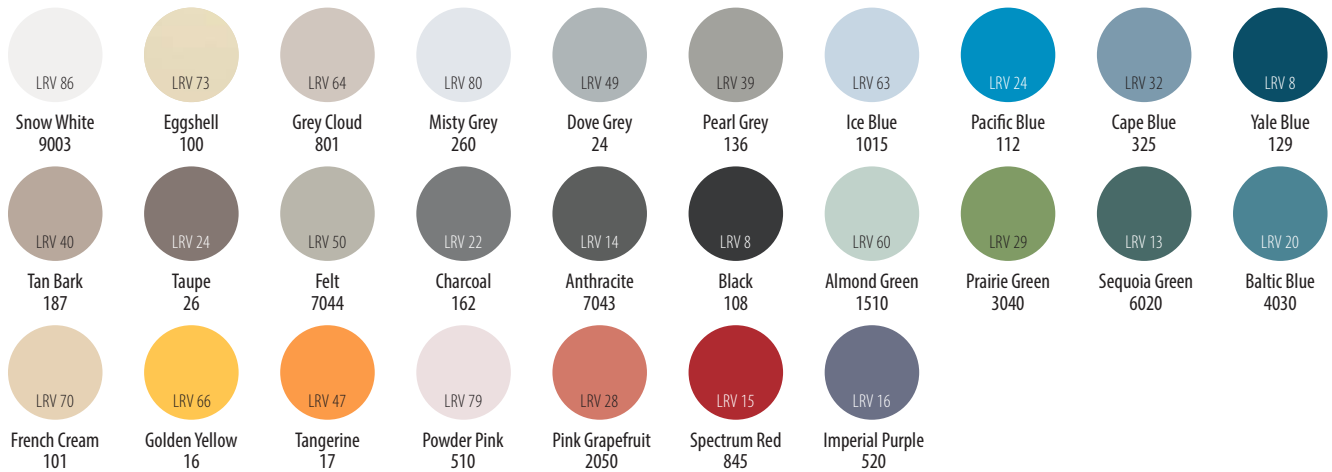

LRV (Light Reflectance Value) indicates the amount of light reflected by a surface and can be used to assess the degree of visual contrast between different surfaces. LRV values for Acrovyn colours have been determined using the CIE Y value measurement method.

FR-225



57 mm high, crescent shaped, unobtrusive rub rails offering light duty protection for walls and doors.



Light Duty

Features & Advantages

- Textured Acrovyn cover over continuous aluminium retainer
- Low profile crescent shape
- Free-floating cover design flexes on impact
- Covers are easy to replace

Applications

- Receptions and waiting areas
- Chair rails
- Conference rooms
- Retail areas

Colours & Texture



Solid Colours
27



Texture
Shadowgrain

See reverse for details.



c-sgroup.eu/388

FR-225

Surface Mounted

Continuous retainer

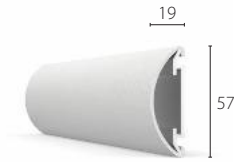

FR-225

Accessories

- End caps
- External corners
- Optional vertical accent trims - black

Stock Lengths & Fixings

- Stock lengths: 4 m
- Fix at max 600 mm centres

Warranty & Lifespan

- 2-year product warranty
- Up to 25-year life expectancy

For Terms and Conditions visit: c-sgroup.eu/16727

Colour Selector

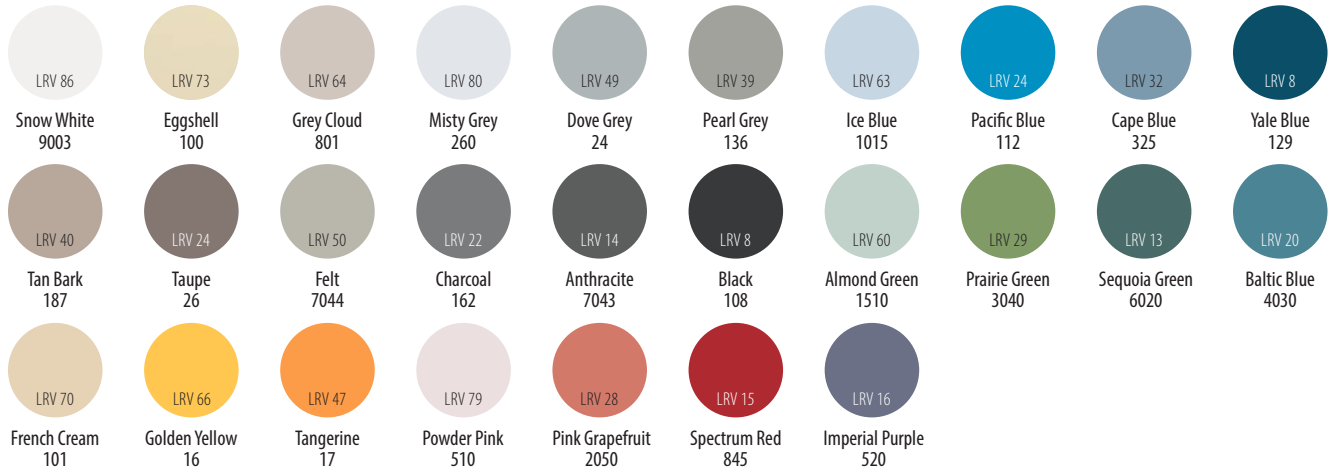

LRV (Light Reflectance Value) indicates the amount of light reflected by a surface and can be used to assess the degree of visual contrast between different surfaces. LRV values for Acrovyn colours have been determined using the CIE Y value measurement method.

TP Series

A range of easy to install rub rails protecting walls from scuffs, scratches and abrasions caused by pedestrian traffic, chairs or lightweight trolleys.



Medium Duty

Features & Advantages

- 3 mm thick, textured and through-coloured rub rails
- Bullnose edges mould profile to the wall
- Four heights to suit project requirements
- Simple installation using tape and adhesive
- Can be used as accent strips and placed at any height

Applications

- Corridors
- Reception and waiting areas
- Offices
- Equipment storage areas

Colours & Texture



Solid Colours
36



Texture
Shadowgrain

See reverse for details.



c-sgroup.eu/390

TP Series

Surface Mounted

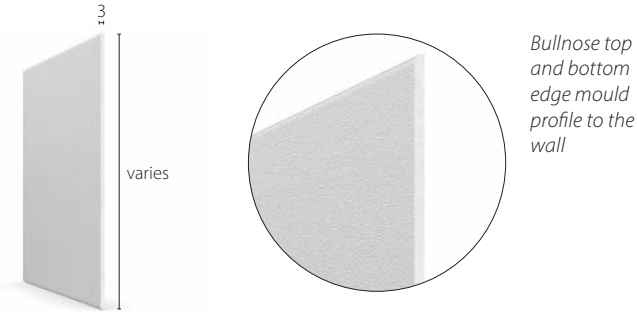

- TP-100 (100 mm high)
- TP-150 (150 mm high)
- TP-200 (200 mm high)
- TP-300 (300 mm high)

Accessories

- Preformed internal or external corners can be supplied to order
- Adhesive foam tape (can be factory applied if required)
- Construction adhesive

Stock Lengths & Fixings





































- Stock lengths: 4 m
- Installation using adhesive foam tape and construction adhesive

Warranty & Lifespan

- 2-year product warranty
- Up to 25-year life expectancy

For Terms and Conditions visit: c-sgroup.eu/16727

Colour Selector

 LRV 86 Snow White 9003	 LRV 83 Pure White 9010	 LRV 74 Mission White 933	 LRV 73 Eggshell 100	 LRV 80 Misty Grey 260	 LRV 49 Dove Grey 24	 LRV 39 Pearl Grey 136	 LRV 50 Felt 7044	 LRV 63 Ice Blue 1015	 LRV 50 Aqua Blue 11
 LRV 64 Grey Cloud 801	 LRV 40 Tan Bark 187	 LRV 24 Taupe 26	 LRV 7 Earth 8019	 LRV 22 Charcoal 162	 LRV 14 Anthracite 7043	 LRV 10 Graphite 7024	 LRV 8 Black 108	 LRV 32 Cape Blue 325	 LRV 24 Pacific Blue 112
 LRV 70 French Cream 101	 LRV 66 Golden Yellow 16	 LRV 47 Tangerine 17	 LRV 15 Spectrum Red 845	 LRV 60 Almond Green 1510	 LRV 56 Anise 22	 LRV 31 Lagoon 5018	 LRV 13 Sequoia Green 6020	 LRV 20 Baltic Blue 4030	 LRV 8 Yale Blue 129
 LRV 79 Powder Pink 510	 LRV 31 Coral Blush 2040	 LRV 28 Pink Grapefruit 2050	 LRV 13 Sugar Plum 32	 LRV 16 Imperial Purple 520	 LRV 29 Prairie Green 3040				

Light Reflectance Value (LRV) indicates the amount of light reflected by a surface and can be used to assess the degree of visual contrast between different surfaces. LRV values for Acrovyn colours have been determined using the CIE Y value measurement method.

SCR-80N



203 mm high, curved-profile crash rails offering a modern aesthetic and extensive impact protection in high traffic areas.



Heavy / Medium
Duty

Features & Advantages

- Impact resistant, textured Acrovyn PVC-Free cover over continuous aluminium retainer as standard
- A version mounted on aluminium clips for areas requiring medium duty protection
- Free-floating cover and internal, continuous bumper cushion effectively absorb impact force
- Covers are easy to replace

Applications

- Corridors with frequent trolley or bed movement
- Production areas and laboratories
- Back of house areas in retail facilities and hotels
- Lift areas and lifts

Colours & Texture



Solid Colours
15



Texture
Shadowgrain

See reverse for details.



c-sgroup.eu/384

SCR-80N

Surface Mounted

Continuous retainer
Heavy Duty

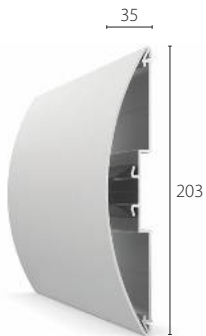

SCR-80MN

Mounting clips
Medium Duty



SCR-80N

Accessories

- End caps
- External corners
- Optional vertical accent trims - black (standard) or light grey

Stock Lengths & Fixings

- Stock lengths: 3 m
- Fix at max 600 mm centres; aluminium clips at max 600 mm centres.

Warranty & Lifespan

- 2-year product warranty
- Up to 25-year life expectancy

For Terms and Conditions visit: c-sgroup.eu/16727

Colour Selector

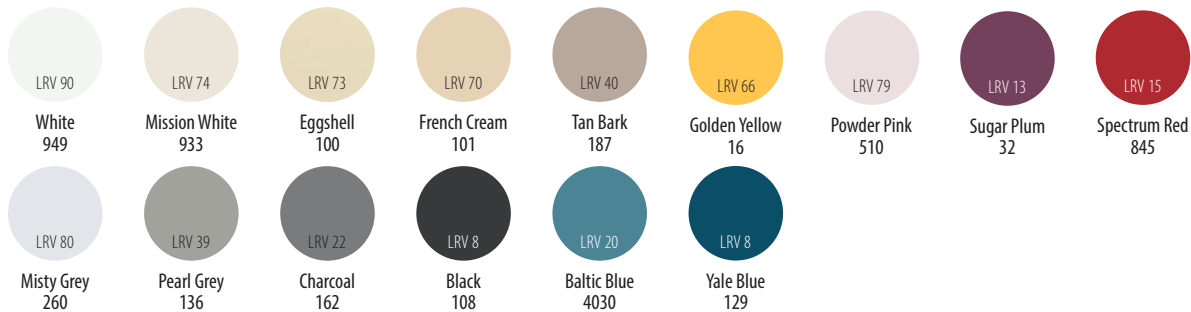

LRV (Light Reflectance Value) indicates the amount of light reflected by a surface and can be used to assess the degree of visual contrast between different surfaces. LRV values for Acrovyn colours have been determined using the CIE Y value measurement method.

SCR-50N



127 mm high, curved-profile crash rails offering reliable protection in areas prone to impact damage.



Heavy / Medium
Duty

Features & Advantages

- Impact resistant, textured Acrovyn PVC-Free cover over continuous aluminium retainer as standard
- A version mounted on aluminium clips for areas requiring medium duty protection
- Free-floating cover and internal, continuous bumper cushion effectively absorb impact force
- Covers are easy to replace

Applications

- Corridors with frequent trolley or bed movement
- Production areas and laboratories
- Back of house areas in retail facilities and hotels
- Lift areas and lifts

Colours & Texture



Solid Colours
15



Texture
Shadowgrain

See reverse for details.



c-sgroup.eu/387

SCR-50N

Surface Mounted

Continuous retainer
Heavy Duty

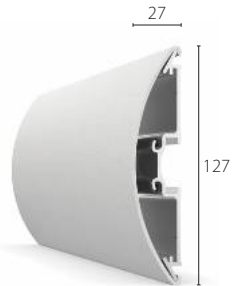

SCR-50MN

Mounting clips
Medium Duty



SCR-50N

Accessories

- End caps
- External corners
- Optional vertical accent trims - black

Stock Lengths & Fixings

- Stock lengths: 3 m
- Fix at max 600 mm centres; aluminium clips at max 600 mm centres.

Warranty & Lifespan

- 2-year product warranty
- Up to 25-year life expectancy

For Terms and Conditions visit: c-sgroup.eu/16727

Colour Selector

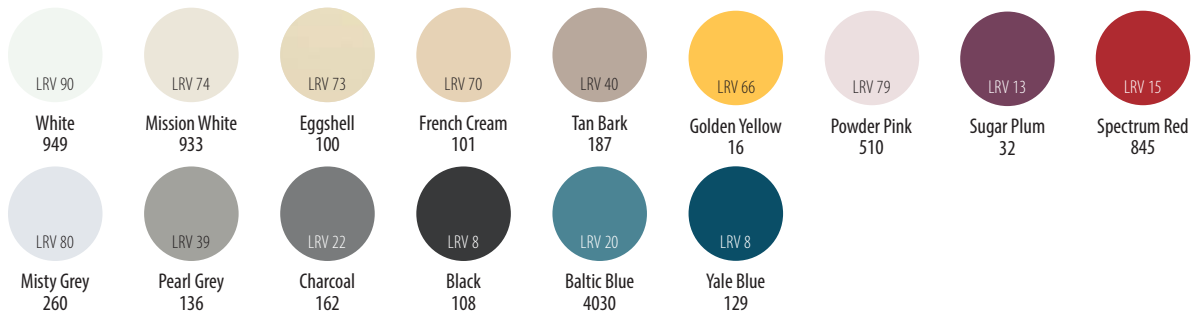

LRV (Light Reflectance Value) indicates the amount of light reflected by a surface and can be used to assess the degree of visual contrast between different surfaces. LRV values for Acrovyn colours have been determined using the CIE Y value measurement method.

SCR-150N



152 mm high, classic flat profile crash rails offering effective protection in areas prone to impact damage.



Heavy / Medium
Duty

Features & Advantages

- Impact resistant, textured Acrovyn PVC-Free cover over continuous aluminium retainer as standard
- A version mounted on aluminium clips for areas requiring medium duty protection
- Free-floating cover design and a continuous, internal bumper cushion for effective impact protection
- Covers are easy to replace

Applications

- Corridors with frequent trolley or bed movement
- Production areas and laboratories
- Back of house areas in retail facilities and hotels
- Lift areas and lifts

Colours & Texture



Solid Colours
15



Texture
Shadowgrain

See reverse for details.



c-sgroup.eu/389

SCR-150N

Surface Mounted

Continuous retainer
Heavy Duty



SCR-150MN

Mounting clips
Medium Duty



SCR-150N

Accessories

- End caps
- External corners

Stock Lengths & Fixings

- Stock lengths: 3 m
- Fix at max 600 mm centres; aluminium clips at max 600 mm centres.

Warranty & Lifespan

- 2-year product warranty
- Up to 25-year life expectancy

For Terms and Conditions visit: [c-sgroup.eu/16727](https://www.c-sgroup.eu/16727)

Colour Selector

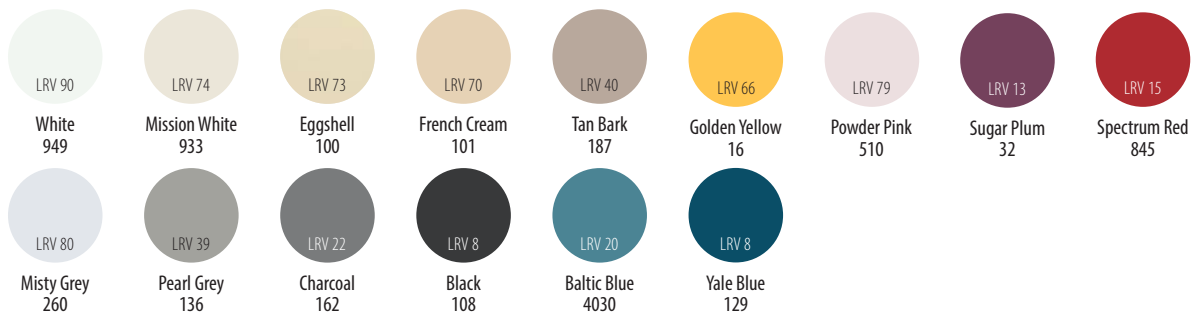

LRV (Light Reflectance Value) indicates the amount of light reflected by a surface and can be used to assess the degree of visual contrast between different surfaces. LRV values for Acrovyn colours have been determined using the CIE Y value measurement method.

BG-10N



102 mm high, bullnose style bumper guards designed to keep wheeled equipment away from the wall. Often used at low level, in combination with handrails or other crash rails.



Medium Duty

Features & Advantages

- Textured Acrovyn PVC-Free cover over continuous aluminium retainer
- Large bullnose profile flexes for maximum bumper action protection
- Mounted on spacers for extra stand-off from the wall
- Covers are easy to replace

Applications

- Corridors
- Reception areas
- Back of house areas
- Lift areas and lifts

Colours & Texture



Solid Colours
15



Texture
Shadowgrain

See reverse for details.



c-sgroup.eu/2535

BG-10N

Spacer Mounted

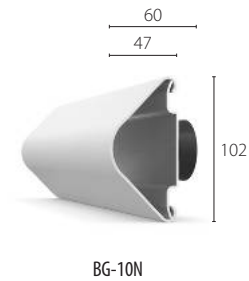

Accessories

- End caps
- External corners

Stock Lengths & Fixings

- Stock lengths: 3 m
- Fix at max 600 mm centres

Warranty & Lifespan

- 2-year product warranty
- Up to 25-year life expectancy

For Terms and Conditions visit: c-sgroup.eu/16727

Colour Selector

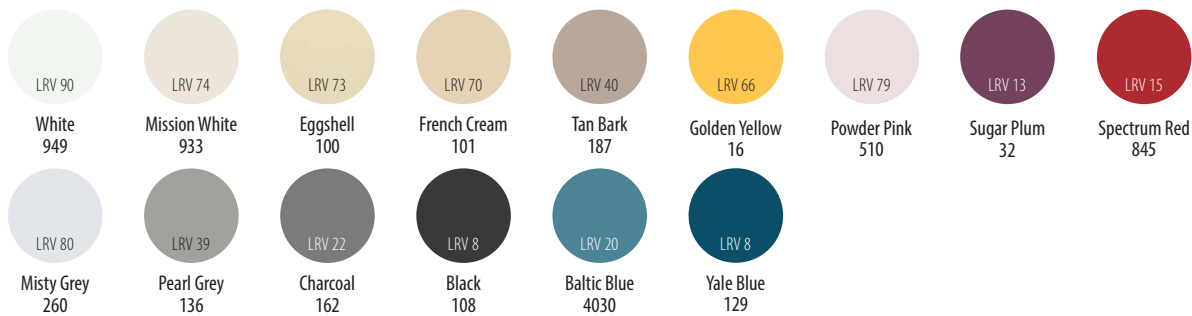

LRV (Light Reflectance Value) indicates the amount of light reflected by a surface and can be used to assess the degree of visual contrast between different surfaces. LRV values for Acrovyn colours have been determined using the CIE Y value measurement method.

FR-225N



57 mm high, crescent shaped, unobtrusive rub rails offering light duty protection for walls and doors.



Light Duty

Features & Advantages

- Textured Acrovyn PVC-Free cover over continuous aluminium retainer
- Low profile crescent shape
- Free-floating cover design flexes on impact
- Covers are easy to replace

Applications

- Receptions and waiting areas
- Chair rails
- Conference rooms
- Retail areas

Colours & Texture



Solid Colours
15



Texture
Shadowgrain

See reverse for details.



c-sgroup.eu/388

FR-225N

Surface Mounted

Continuous retainer

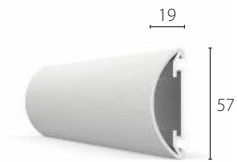

FR-225N

Accessories

- End caps
- External corners
- Optional vertical accent trims - black

Stock Lengths & Fixings

- Stock lengths: 3 m
- Fix at max 600 mm centres

Warranty & Lifespan

- 2-year product warranty
- Up to 25-year life expectancy

For Terms and Conditions visit: c-sgroup.eu/16727

Colour Selector

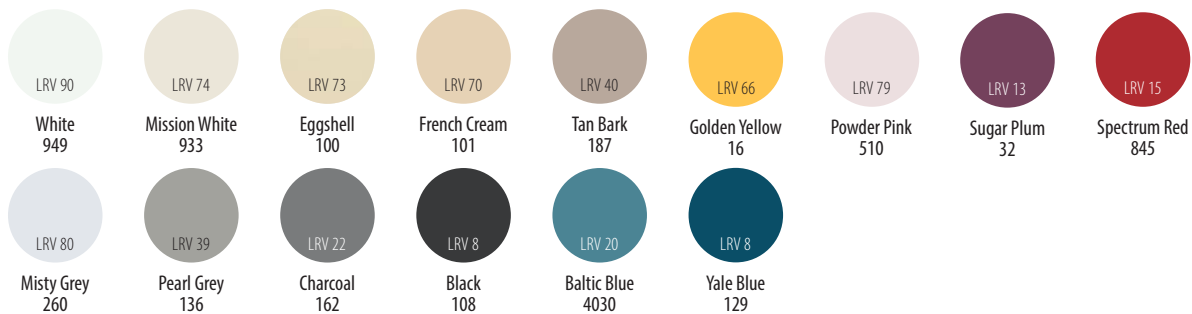

LRV (Light Reflectance Value) indicates the amount of light reflected by a surface and can be used to assess the degree of visual contrast between different surfaces. LRV values for Acrovyn colours have been determined using the CIE Y value measurement method.

CRC-150

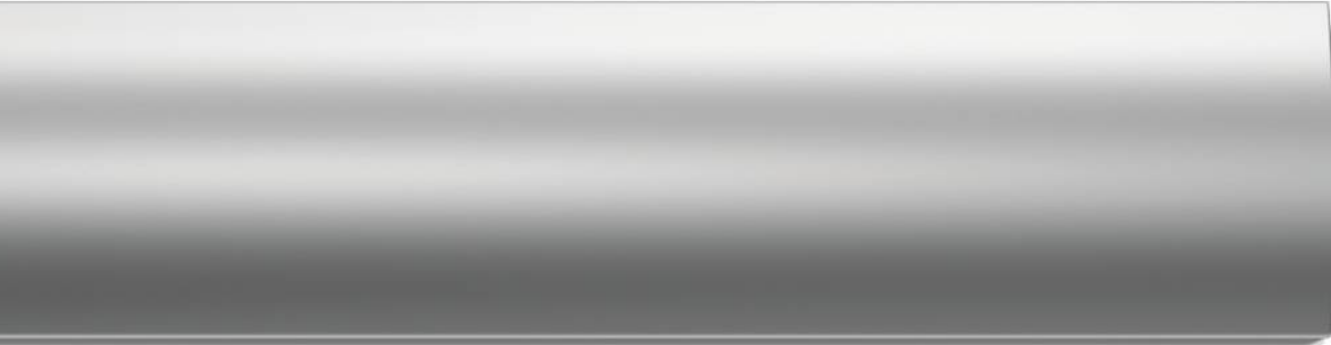

150 mm high, robust stainless steel crash rails in a curved profile, suitable for ultra-clean environments.



Heavy Duty

Features & Advantages

- Stainless steel cover in a brushed finish
- End caps welded to surveyed rail lengths for ease of installation
- Mounted over a continuous aluminium retainer for added strength

Applications

- Kitchens and food serving areas
- Laboratories
- Pharmaceutical manufacturing
- Food manufacturing
- Retail areas
- Corridors with regular wheeled traffic
- Back of house areas

Material & Finish



Stainless Steel
Grade 304L



Finish
Brushed



c-sgroup.eu/394

CRC-150

Surface Mounted

Continuous retainer

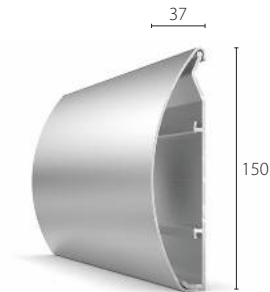

CRC-150

Accessories

- End caps welded to surveyed rail lengths

Stock Lengths & Fixings

- Lengths to cutting schedule from stock lengths of max 3 m
- Fix at max 400 mm centres

Warranty & Lifespan

- 2-year product warranty
- Life expectancy over 25 years

For Terms and Conditions visit: c-sgroup.eu/16727



CRS Series



A range of stainless steel crash rails in a classic profile, offering high durability and impact protection.



Heavy Duty

Features & Advantages

- Stainless steel cover in a brushed finish
- Available in three heights to suit project requirements
- End caps welded to surveyed rail lengths for ease of installation
- Mounted using pre-drilled continuous stainless steel clips

Applications

- Kitchens and food serving areas
- Laboratories
- Pharmaceutical manufacturing
- Food manufacturing
- Retail areas
- Corridors with regular wheeled traffic
- Back of house areas

Material & Finish



Stainless Steel
Grade 304L



Finish
Brushed



c-sgroup.eu/6869

CRS Series

Surface Mounted

All sizes feature 2 continuous fixing clips

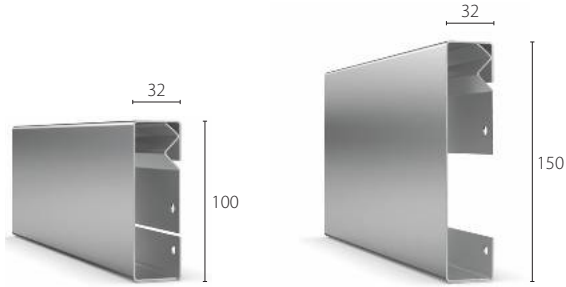

CRS-100

CRS-150

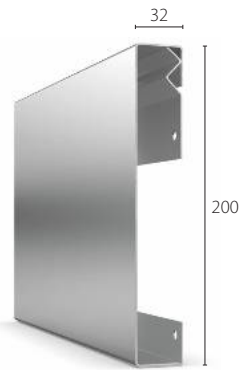

CRS-200

Accessories

- End caps welded to surveyed rail lengths
- Supplied complete with top and bottom stainless steel clips

Stock Lengths & Fixings

- Lengths to cutting schedule from stock lengths of max 3 m
- Continuous fixing clips supplied pre-drilled in lengths to suit profile sizes

Warranty & Lifespan

- 2-year product warranty
- Life expectancy over 25 years

For Terms and Conditions visit: c-sgroup.eu/16727

LLRSS



Severe duty, stainless steel crash rails, ideal for protecting fully glazed corridor walls and other interior features.



Severe Duty

Features & Advantages

- 51 mm ø stainless steel tubular rail
- Mounted on robust stainless steel brackets for extra stability
- Suitable for floor or wall mounting
- Radiused sections can be supplied to be fitted around columns and other features (min 800 mm radius)

Applications

- Glazed corridors with regular wheeled traffic
- Laboratories
- Pharmaceutical and food manufacturing
- Retail areas
- Back of house areas

Material & Finish



Stainless Steel
Grade 304L



Finish
Brushed



c-sgroup.eu/395

LLRSS

Mounting Options

Floor mounted

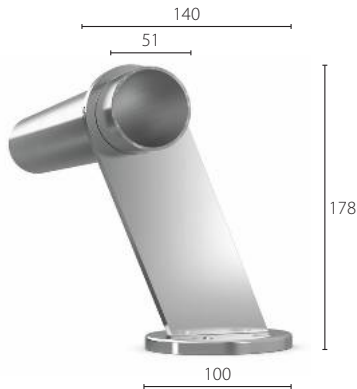

Wall mounted

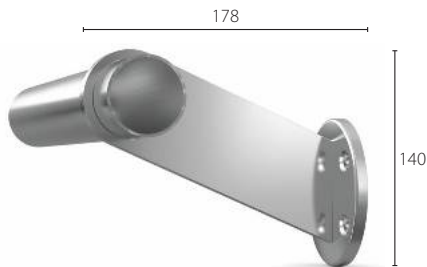

Accessories

- End caps
- End stops
- Internal / external corners
- Brackets for floor / wall mounting

Stock Lengths & Fixings

- Stock lengths: 3 m
- Brackets at max 1 m centres

Warranty & Lifespan

- 2-year product warranty
- Life expectancy over 25 years

For Terms and Conditions visit: [c-sgroup.eu/16727](https://www.c-sgroup.eu/16727)



PP-76

Severe duty, stainless steel posts designed to protect architectural features, corners and doors by deflecting wheeled traffic away.



Severe Duty

Features & Advantages

- Robust stainless steel posts designed for floor mounting
- Supplied with a base plate cover to conceal fixings, for a neat finish
- 900 mm high as standard, or can be cut down to a required height
- Complete with domed stainless steel cap

Applications

- Corridors with regular wheeled traffic
- Retail areas
- Food manufacturing
- Pharmaceutical manufacturing
- Laboratories
- Back of house areas

Material & Finish



Stainless Steel
Grade 304L



Finish
Brushed



c-sgroup.eu/2543



PP-76

Floor Mounted

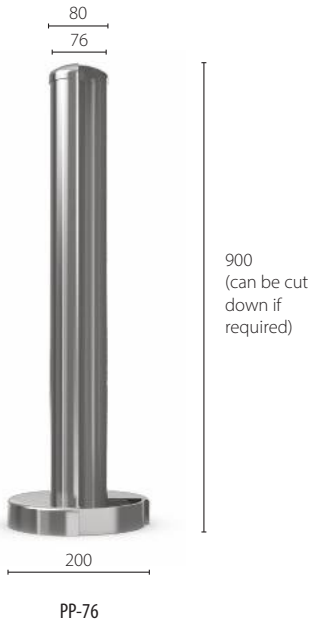

Stock Lengths & Fixings

- 900 mm high as standard, can be cut down if required

Warranty & Lifespan

- 2-year product warranty
- Life expectancy over 25 years

For Terms and Conditions visit: c-sgroup.eu/16727

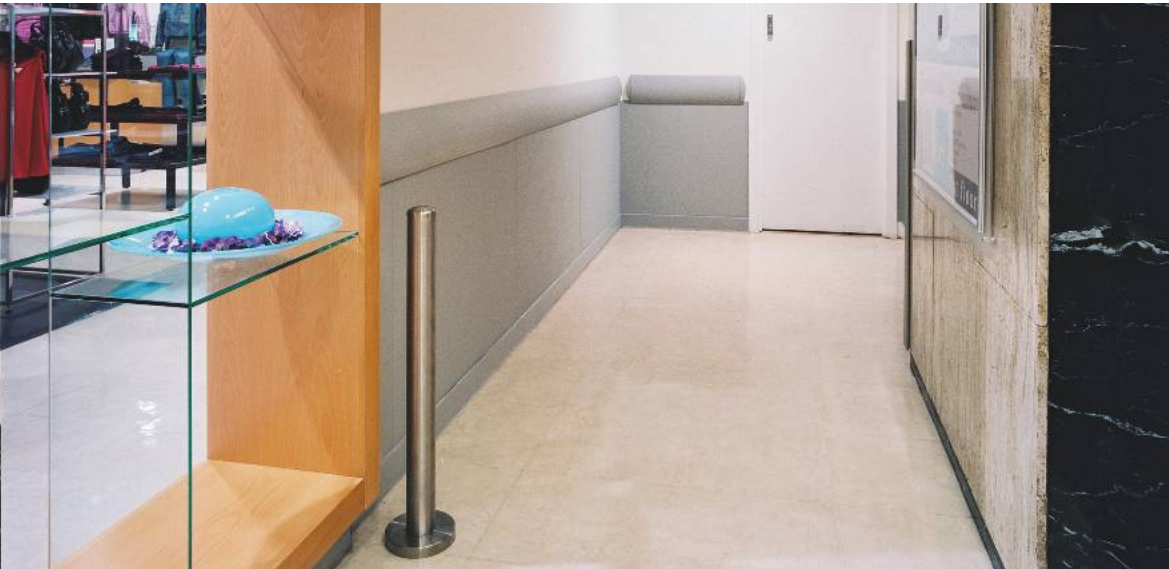

200W Series



200 mm high, severe duty EPDM rubber crash rails, capable of withstanding the toughest knocks in back of house, delivery and car park areas.



Severe Duty

Features & Advantages

- EPDM rubber crash rails available in two thicknesses to suit project requirements
- Suitable for interior and exterior applications
- Optional light reflective or hazard tapes
- Can be fixed to circular columns using steel binding
- External and internal corners can be achieved through on-site mitering

Applications

- Service corridors
- Back of house areas
- Loading bays
- Baggage reclaim
- Warehouses
- Car parks

Material & Colour



EPDM Rubber
Black



c-sgroup.eu/406

200W Series

Surface Mounted

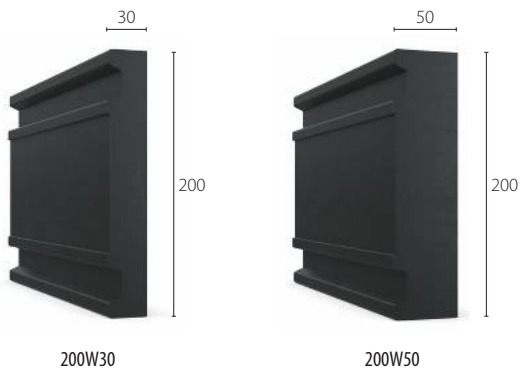

Accessories

- Optional light reflective, self adhesive inserts - white or yellow/black



Stock Lengths & Fixings

- Stock lengths: 3 m
- Fix at max 300 mm staggered centres

Warranty & Lifespan

- 2-year product warranty
- Life expectancy over 25 years

For Terms and Conditions visit: c-sgroup.eu/16727



150W20

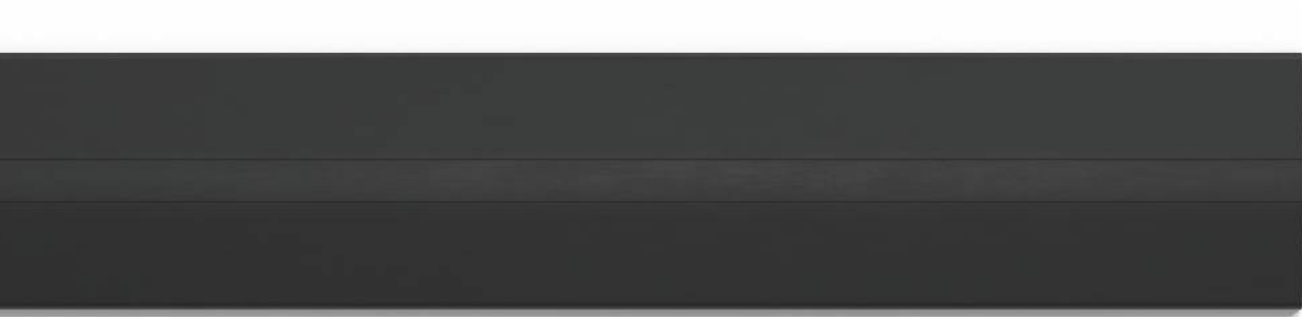

150 mm high, slimline EPDM rubber crash rails used for protecting walls from damage caused by trolleys, carts and vehicles.



Severe Duty

Features & Advantages

- Robust EPDM rubber crash rails
- Supplied with an internal aluminium strip for firm wall fastening
- Snap-in EPDM rubber cover strip conceals fixings for a neat finish
- Suitable for interior and exterior applications
- External and internal corners can be achieved through on-site mitering

Applications

- Service corridors
- Back of house areas
- Loading bays
- Baggage reclaim
- Warehouses
- Car parks

Material & Colour



EPDM Rubber
Black



c-sgroup.eu/407

150W20

Surface Mounted



150W20

Stock Lengths & Fixings

- Stock lengths: 3 m
- Fix at max 400 mm centres

Warranty & Lifespan

- 2-year product warranty
- Life expectancy over 25 years

For Terms and Conditions visit: [c-sgroup.eu/16727](https://www.c-sgroup.eu/16727)

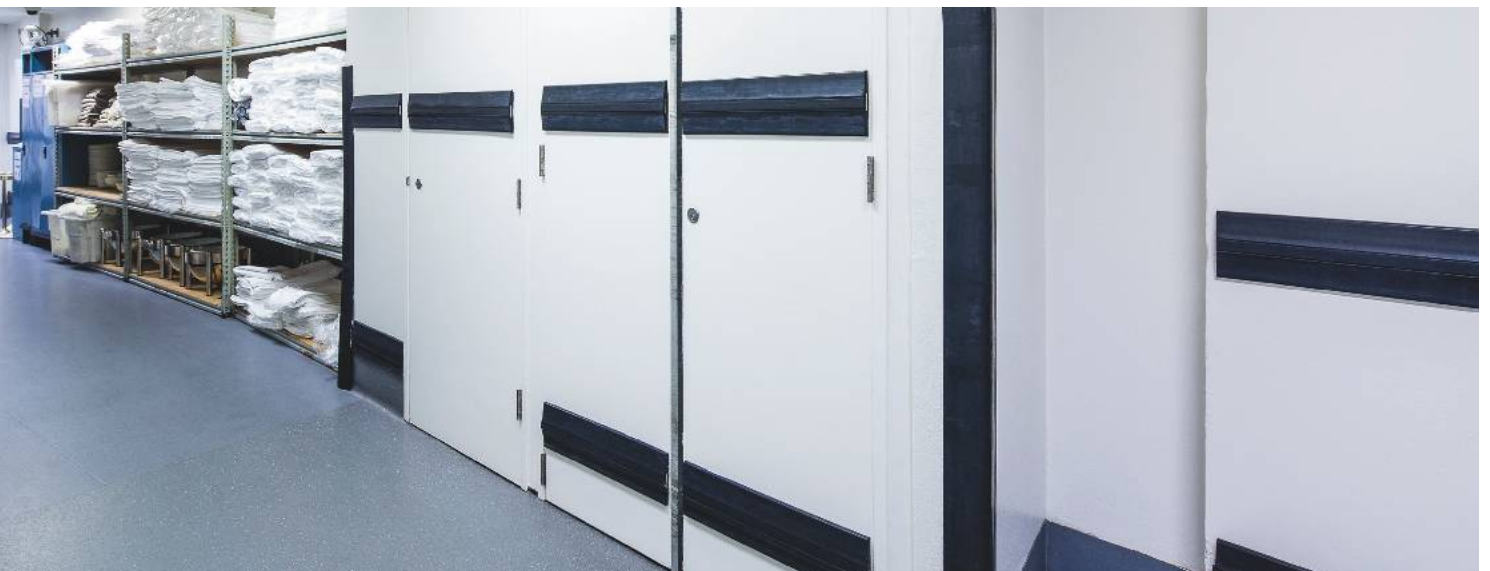

D Series



75 or 100 mm high, D-section EPDM rubber crash rails offering severe duty impact protection in interior and exterior areas.



Severe Duty

Features & Advantages

- Robust EPDM rubber crash rails
- Available in two sizes to suit project requirements
- Suitable for interior and exterior applications
- Hollow design flexes under impact, absorbing its force
- Optional rubber end plugs and bolt bung covers available
- External and internal corners can be achieved through on-site mitering

Applications

- Service corridors
- Back of house areas
- Loading bays
- Baggage reclaim
- Warehouses
- Car parks

Material & Colour



EPDM Rubber
Black



c-sgroup.eu/408

D Series

Surface Mounted

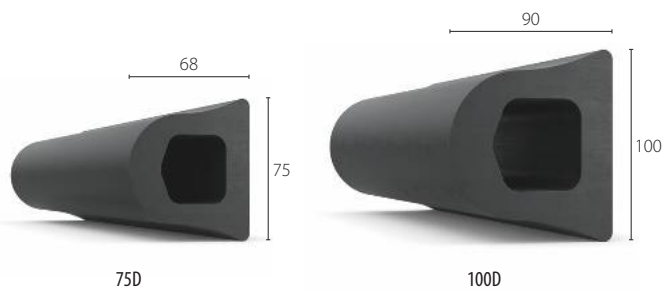

Accessories

- End plugs
- Bolt bung covers

Stock Lengths & Fixings

- Stock lengths: 3 m
- Fix at max 400 mm centres. Sections require drilling on-site, or can be supplied pre-drilled to special order.

Warranty & Lifespan

- 2-year product warranty
- Life expectancy over 25 years

For Terms and Conditions visit: c-sgroup.eu/16727

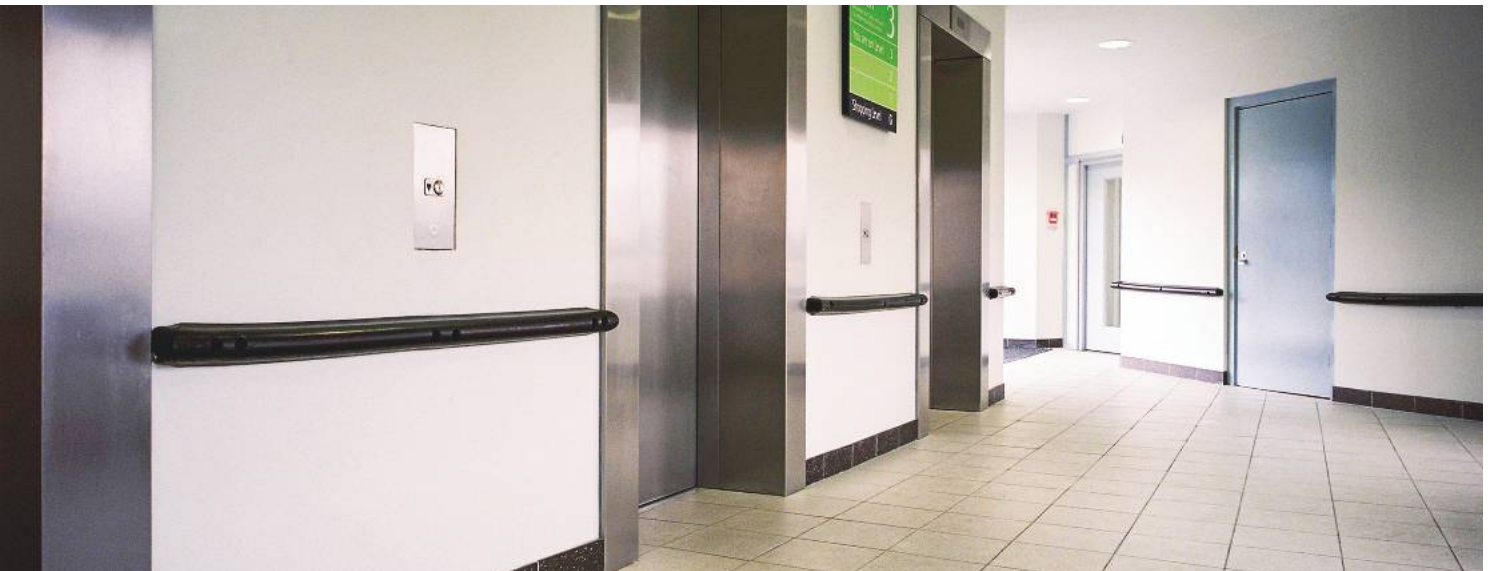

60B

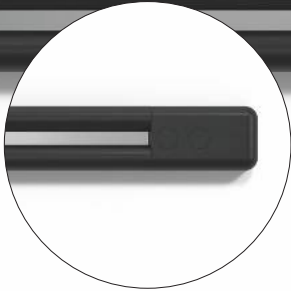

60 mm high, unobtrusive B-section EPDM rubber guards offering heavy duty impact protection in back of house areas.



Heavy Duty

Features & Advantages

- Tough EPDM rubber guards
- Continuous aluminium fixing strip for firm fixing to the wall
- Suitable for interior and exterior applications
- External and internal corners can be achieved through on-site mitering

Applications

- Back of house areas
- Lift areas
- Baggage reclaim
- Warehouses

Material & Colour



EPDM Rubber
Black



c-sgroup.eu/410

60B

Surface Mounted

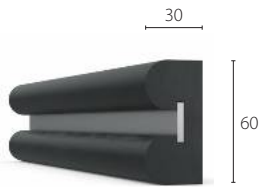

60B

Accessories

- End caps

Stock Lengths & Fixings

- Stock lengths: 3 m
- Fix at max 400 mm centres

Warranty & Lifespan

- 2-year product warranty
- Life expectancy over 25 years

For Terms and Conditions visit: c-sgroup.eu/16727



Acrovyn[®] *Bed Head Protection*

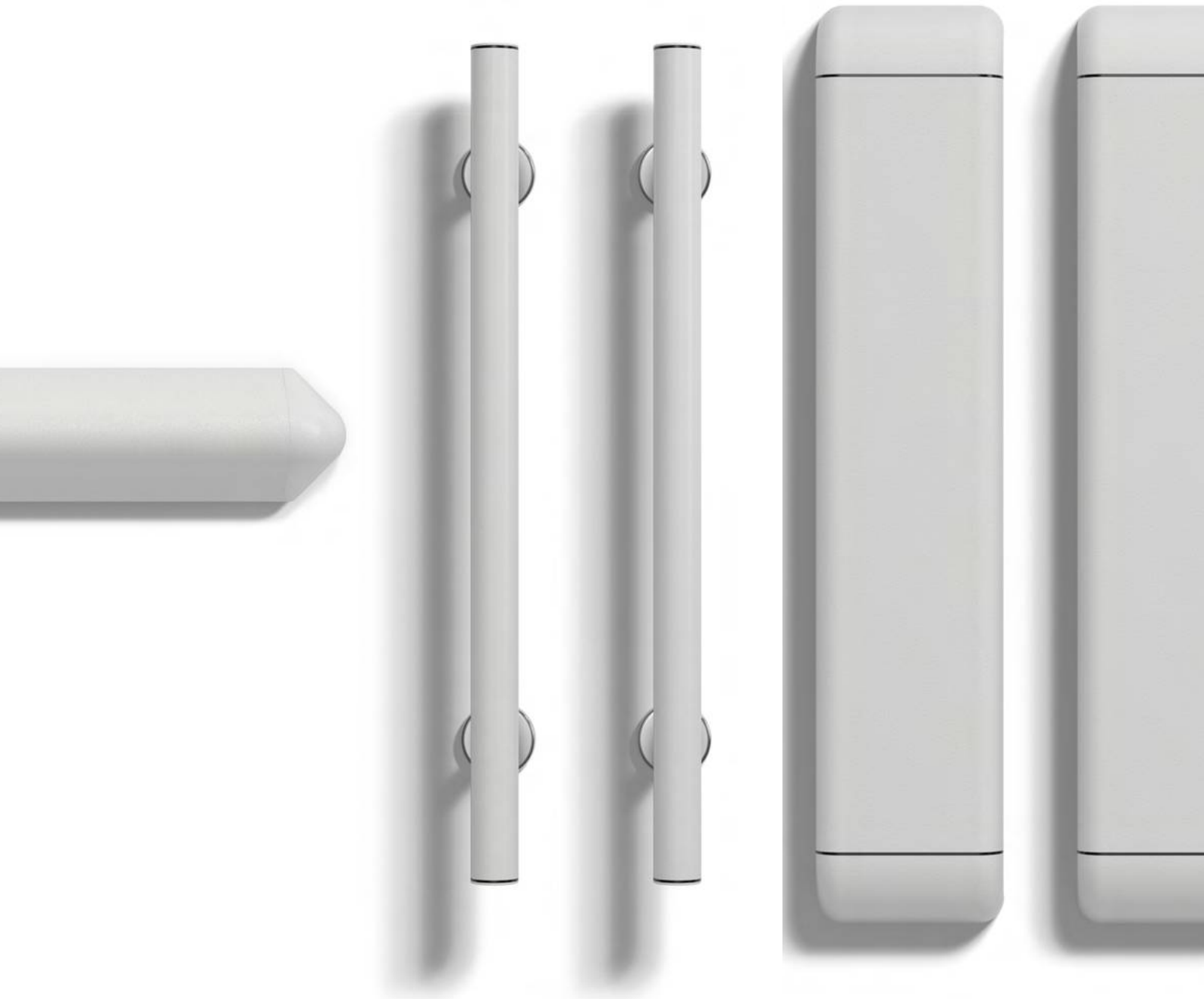

BL-10H



Horizontal bed head protectors designed to prevent damage to wall and wall mounted equipment from frequently moved beds.



Medium Duty

Features & Advantages

- Impact resistant, textured Acrovyn cover over continuous aluminium retainer
- Shock-absorbing cover flexes on impact
- Mounted on spacers or custom length, powder coated aluminium brackets
- Supplied as kits for ease of installation
- Cover and end caps are easy to replace

Applications

- Healthcare wards, en-suite rooms and intensive care units
- Care homes

Colours & Texture



Solid Colours
27



Texture
Shadowgrain

See reverse for details.



c-sgroup.eu/2565

BL-10H

Mounting Options

Spacer mount

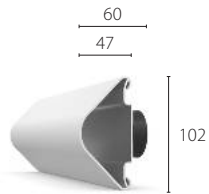

BL-10H

Extended bracket

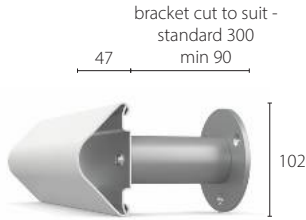

BL-10HE

Extended brackets are powder coated RAL 9006 as standard.

Accessories

- Supplied pre-cut, with end caps and mounting accessories included

Stock Lengths & Fixings

- Standard width: 1.1 m (including end caps); 1.6 m max
- Extended brackets: 300 mm long as standard or cut to suit (min 90 mm)
- Fix at max 400 mm centres. Fixing to studwork or pattresses is recommended, particularly for variants mounted on brackets.

Warranty & Lifespan

- 2-year product warranty
- Up to 25-year life expectancy

For Terms and Conditions visit: c-sgroup.eu/16727

Colour Selector

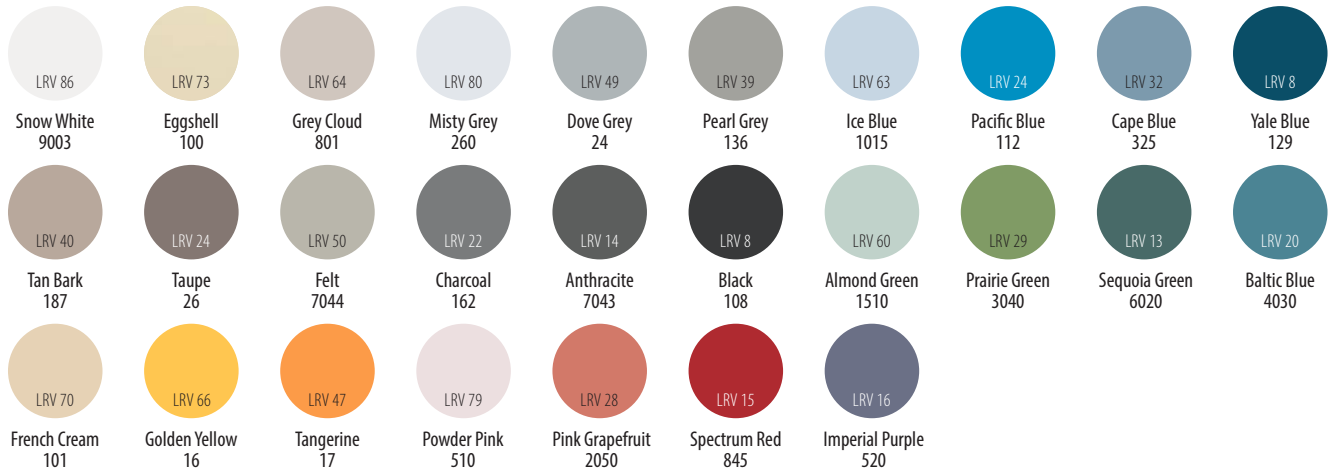

LRV (Light Reflectance Value) indicates the amount of light reflected by a surface and can be used to assess the degree of visual contrast between different surfaces. LRV values for Acrovyn colours have been determined using the CIE Y value measurement method.

BL-10V

Pairs of vertical bed head protectors for applications where beds are often moved around and their heights are frequently adjusted.



Medium Duty

Features & Advantages

- Impact resistant, textured Acrovyn cover over continuous aluminium retainer
- Shock absorbing cover flexes on impact
- Mounted on spacers or custom length, powder coated aluminium brackets
- Supplied as kits for ease of installation
- Cover and end caps are easy to replace

Applications

- Healthcare wards, en-suite rooms and intensive care units
- Care homes

Colours & Texture



Solid Colours
27



Texture
Shadowgrain

See reverse for details.



c-sgroup.eu/2568

BL-10V

Mounting Options

Spacer mount

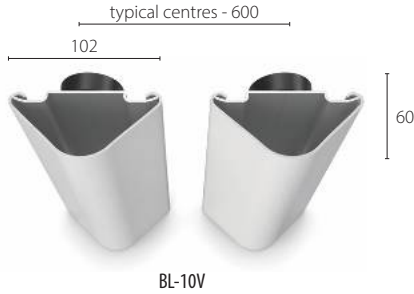

BL-10V

Extended bracket



BL-10VE

Extended brackets are powder coated RAL 9006 as standard.

Accessories

- Supplied pre-cut, with end caps and mounting accessories included

Stock Lengths & Fixings

- Standard height: 700 mm (including end caps)
- Extended brackets: 300 mm long or cut to suit (min 90 mm)
- Fix at max 400 mm vertical centres. Fixing to studwork or pattresses is recommended, particularly for extended bracket variants.

Warranty & Lifespan

- 2-year product warranty
- Up to 25-year life expectancy

For Terms and Conditions visit: c-sgroup.eu/16727

Colour Selector

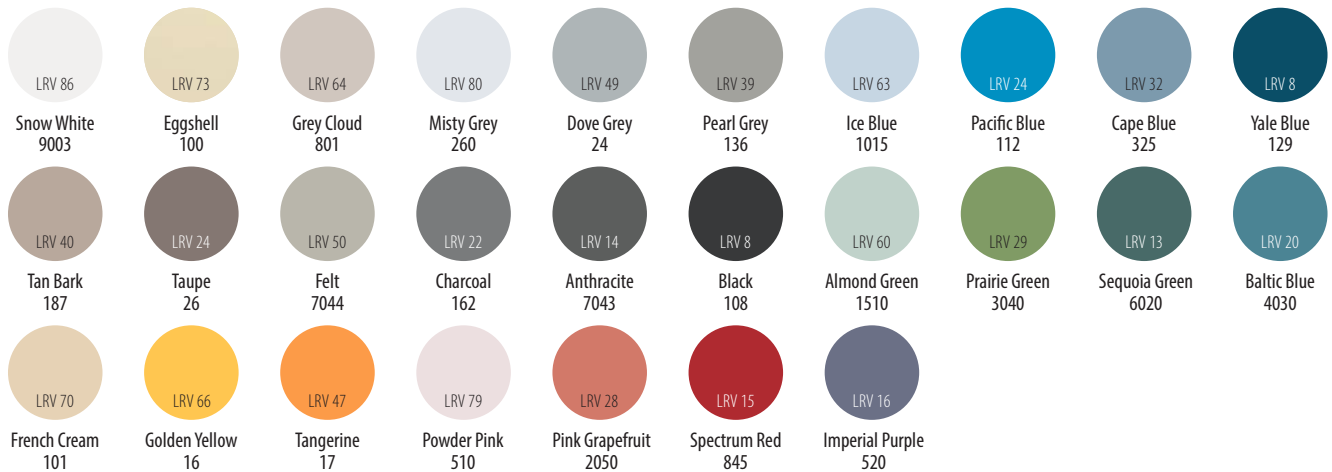

LRV (Light Reflectance Value) indicates the amount of light reflected by a surface and can be used to assess the degree of visual contrast between different surfaces. LRV values for Acrovyn colours have been determined using the CIE Y value measurement method.

BL-4C

Pairs of vertical bed head protectors offering reliable protection to walls and wall mounted equipment from damage caused by frequently moved beds.



Severe Duty



Quick Lock

Features & Advantages

- Impact resistant, textured Acrovyn cover over continuous aluminium retainer
- Free-floating cover and internal, continuous bumper cushion for robust impact protection
- Mounted on Quick Lock brackets or custom length, powder coated aluminium brackets
- Infill strip closes off retainer channel to aid cleaning
- Supplied as kits for ease of installation

Applications

- Healthcare wards, en-suite rooms and intensive care units
- Care homes

Colours & Texture



Solid Colours
27



Texture
Shadowgrain

See reverse for details.



c-sgroup.eu/2571

BL-4C

Mounting Options

Quick Lock

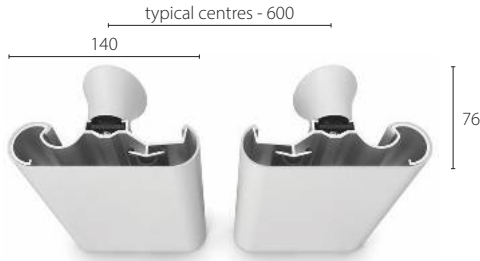

BL-4C

Quick Lock brackets are supplied in a colour matching cover.

Extended bracket



BL-4CE

Extended brackets are powder coated RAL 9006 as standard.

Accessories

- Supplied pre-cut, with end caps and mounting accessories included
- Optional accent trims - black

Stock Lengths & Fixings

- Standard height: 700 mm (including end caps)
- Extended brackets: 300 mm long or cut to suit (min 90 mm)
- Fix at max 350 mm vertical centres. Fixing to studwork or pattresses is recommended, particularly for extended bracket variants.

Warranty & Lifespan

- 2-year product warranty
- Up to 25-year life expectancy

For Terms and Conditions visit: c-sgroup.eu/16727

Colour Selector

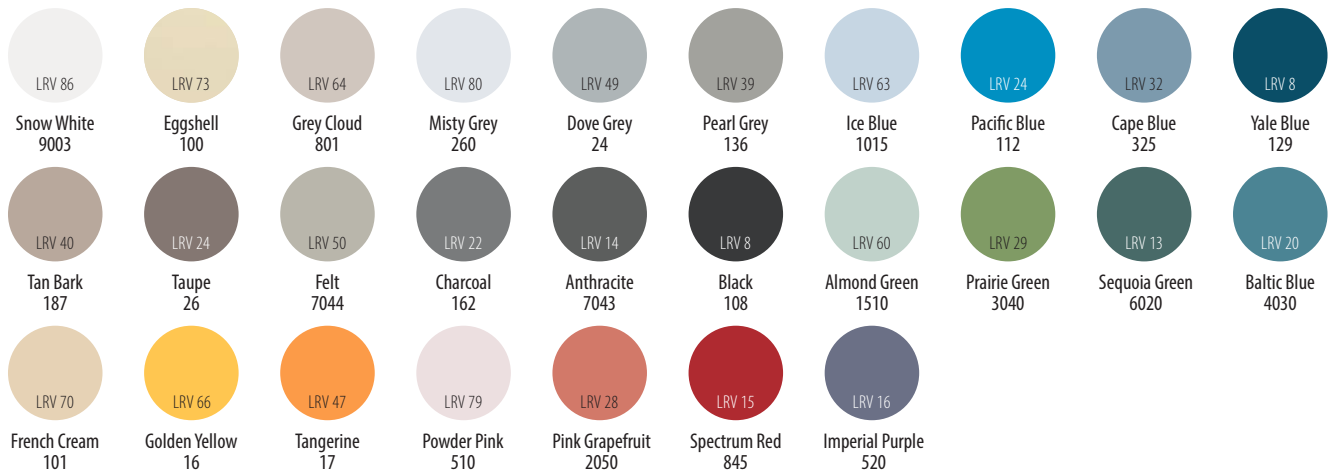

LRV (Light Reflectance Value) indicates the amount of light reflected by a surface and can be used to assess the degree of visual contrast between different surfaces. LRV values for Acrovyn colours have been determined using the CIE Y value measurement method.

BL-40V

Pairs of unobtrusive, vertical bed head protectors designed to protect walls from damage caused by frequently moved or height-adjusted beds.



Medium Duty



Bactericide Certified

Features & Advantages

- A pair of tubular, 40 mm Ø bed head protectors
- Smooth cover with bactericidal additives*, ideal for hygienic environments (tested to ISO 22196, see reverse for more details)
- Continuous aluminium retainer for strength
- Mounted on stainless steel brackets
- Supplied as kits for ease of installation

Applications

- Healthcare wards, en-suite rooms and intensive care units
- Care homes

Colours & Texture



Solid Colours
27



Texture
Smooth

See reverse for details.

* Acrovyn Bactericide material contains Sanitized® zinc pyrithione as an antimicrobial additive. Sanitized® is a registered trademark of Sanitized AG.



c-sgroup.eu/8515



BL-40V

Bracket Mounted

Stainless steel brackets

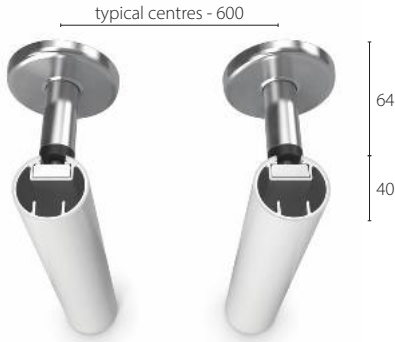

BL-40V

Accessories

- Supplied pre-cut, with end stops and brackets included
- Optional accent trims - black (standard) or light grey

Stock Lengths & Fixings

- Standard height: 700 mm (including end stops)
- Stainless steel brackets provide 104 mm overall projection from the wall
- Fix at max 500 mm vertical centres. Fixing to studwork or pattresses is recommended.

Warranty & Lifespan

- 2-year product warranty
- Up to 25-year life expectancy

For Terms and Conditions visit: c-sgroup.eu/16727

Certifications & Testing

Tested to ISO 22196 and classified under EN 1040.

Bactericidal against:

Escherichia coli



Activity in log: 5.4

Staphylococcus aureus



Activity in log: 5.1

Mycobacterium smegmatis



Activity in log: >5

Bacteriostatic against:

MRSA



Activity in log: 3.92

Salmonella enteritidis



Activity in log: 4.1

Listeria monocytogenes



Activity in log: 2.661

Enterococcus species



Activity in log: 2.28

Colour Selector

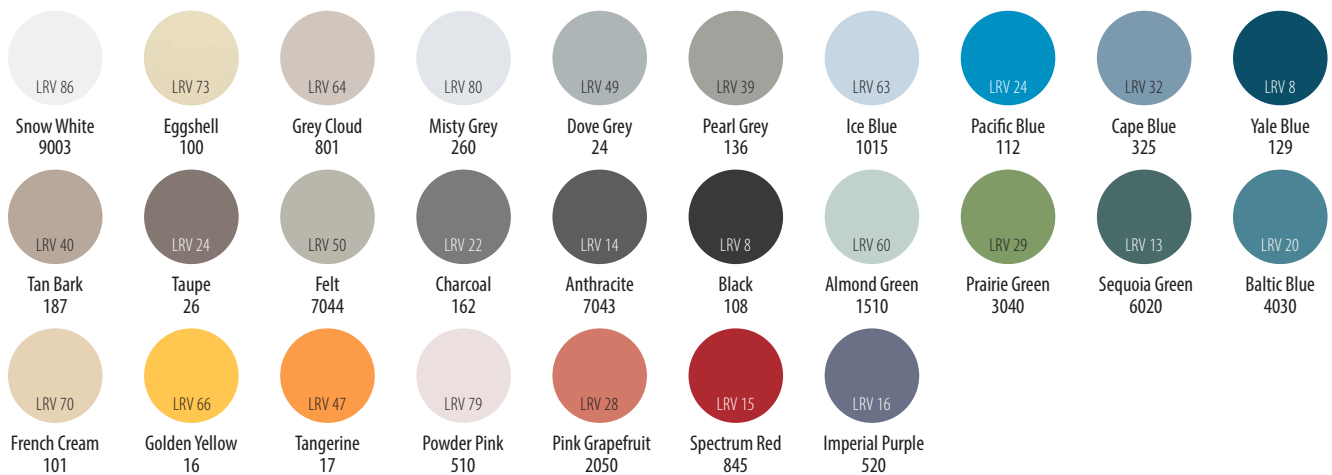

LRV (Light Reflectance Value) indicates the amount of light reflected by a surface and can be used to assess the degree of visual contrast between different surfaces. LRV values for Acrovyn colours have been determined using the CIE Y value measurement method.

BL-10HN



Horizontal bed head protectors designed to prevent damage to wall and wall mounted equipment from frequently moved beds.



Medium Duty

Features & Advantages

- Impact resistant, textured Acrovyn PVC-Free cover over continuous aluminium retainer
- Shock absorbing cover flexes on impact
- Mounted on spacers or custom length, powder coated aluminium brackets
- Supplied as kits for ease of installation
- Cover and end caps are easy to replace

Applications

- Healthcare wards, en-suite rooms and intensive care units
- Care homes

Colours & Texture



Solid Colours
15



Texture
Shadowgrain

See reverse for details.



c-sgroup.eu/2565

BL-10HN

Mounting Options

Spacer mount

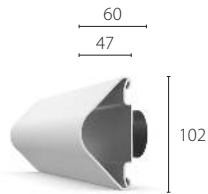

BL-10HN

Extended bracket

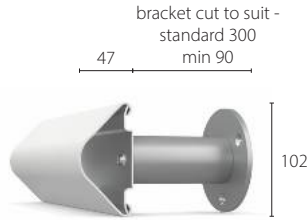

BL-10HEN

Extended brackets are powder coated RAL 9006 as standard.

Accessories

- Supplied pre-cut, with end caps and mounting accessories included

Stock Lengths & Fixings

- Standard width: 1.1 m (including end caps); 1.6 m max
- Extended brackets: 300 mm long as standard or cut to suit (min 90 mm)
- Fix at max 400 mm centres. Fixing to studwork or pattresses is recommended, particularly for variants mounted on brackets.

Warranty & Lifespan

- 2-year product warranty
- Up to 25-year life expectancy

For Terms and Conditions visit: c-sgroup.eu/16727

Colour Selector

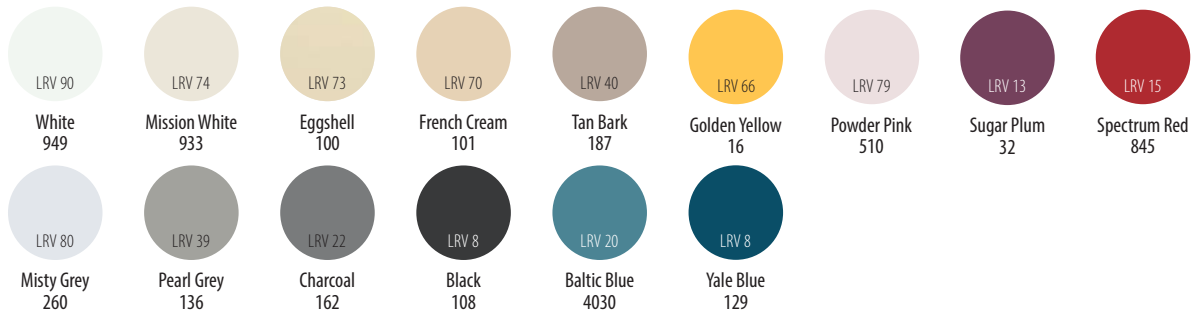

LRV (Light Reflectance Value) indicates the amount of light reflected by a surface and can be used to assess the degree of visual contrast between different surfaces. LRV values for Acrovyn colours have been determined using the CIE Y value measurement method.

BL-10VN

Pairs of vertical bed head protectors for applications where beds are often moved around and their heights are frequently adjusted.



Medium Duty

Features & Advantages

- Impact resistant, textured Acrovyn PVC-Free cover over continuous aluminium retainer
- Shock absorbing cover flexes on impact
- Mounted on spacers or custom length, powder coated aluminium brackets
- Supplied as kits for ease of installation
- Cover and end caps are easy to replace

Applications

- Healthcare wards, en-suite rooms and intensive care units
- Care homes

Colours & Texture



Solid Colours
15



Texture
Shadowgrain

See reverse for details.



c-sgroup.eu/2568

BL-10VN

Mounting Options

Spacer mount

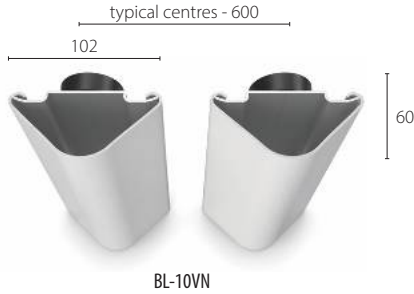

Extended bracket

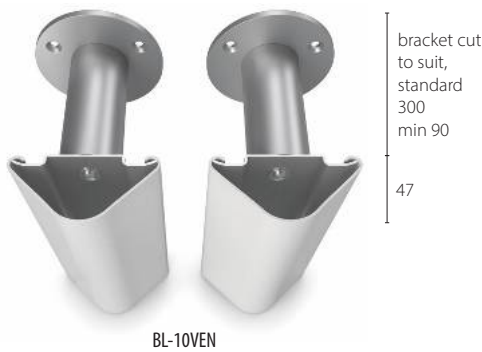

Extended brackets are powder coated RAL 9006 as standard.

Accessories

- Supplied pre-cut, with end caps and mounting accessories included

Stock Lengths & Fixings

- Standard height: 700 mm (including end caps)
- Extended brackets: 300 mm long, or cut to suit (min 90 mm)
- Fix at max 400 mm vertical centres. Fixing to studwork or pattresses is recommended, particularly for extended bracket variants.

Warranty & Lifespan

- 2-year product warranty
- Up to 25-year life expectancy

For Terms and Conditions visit: c-sgroup.eu/16727

Colour Selector

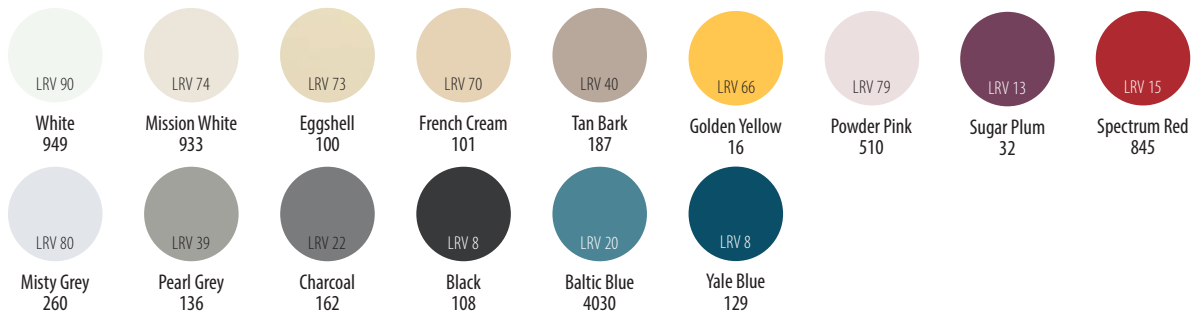

LRV (Light Reflectance Value) indicates the amount of light reflected by a surface and can be used to assess the degree of visual contrast between different surfaces. LRV values for Acrovyn colours have been determined using the CIE Y value measurement method.

BL-4CN

Pairs of vertical bed head protectors offering reliable protection to walls and wall mounted equipment from damage caused by frequently moved beds.



Severe Duty



Quick Lock

Features & Advantages

- Impact resistant, textured Acrovyn PVC-Free cover over continuous aluminium retainer
- Free-floating cover and internal, continuous bumper cushion for robust impact protection
- Mounted on Quick Lock brackets or custom length, powder coated aluminium brackets
- Infill strip closes off retainer channel to aid cleaning
- Supplied as kits for ease of installation

Applications

- Healthcare wards, en-suite rooms and intensive care units
- Care homes

Colours & Texture



Solid Colours
15



Texture
Shadowgrain

See reverse for details.



c-sgroup.eu/2571

BL-4CN

Mounting Options

Quick Lock

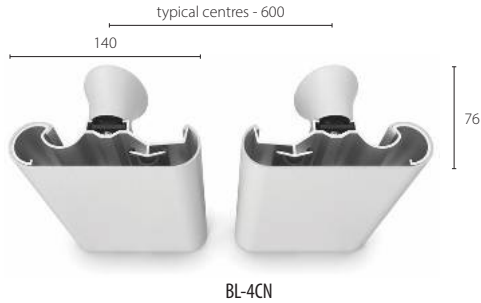

Quick Lock brackets are supplied in a colour matching cover.

Extended bracket



Extended brackets are powder coated RAL 9006 as standard.

Accessories

- Supplied pre-cut, with end caps and mounting accessories included
- Optional accent trims - black

Stock Lengths & Fixings

- Standard height: 700 mm (including end caps)
- Extended brackets: 300 mm long or cut to suit (min 90 mm)
- Fix at max 350 mm vertical centres. Fixing to studwork or pattresses is recommended, particularly for extended bracket variants.

Warranty & Lifespan

- 2-year product warranty
- Up to 25-year life expectancy

For Terms and Conditions visit: c-sgroup.eu/16727

Colour Selector

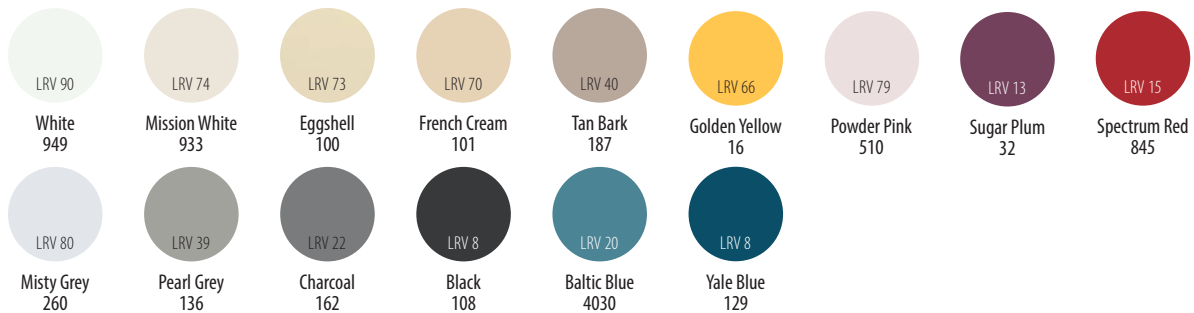

LRV (Light Reflectance Value) indicates the amount of light reflected by a surface and can be used to assess the degree of visual contrast between different surfaces. LRV values for Acrovyn colours have been determined using the CIE Y value measurement method.

Acrovyn[®] *Door Protection*



Door Cladding

Bespoke manufactured Acrovyn Door Cladding creates a highly durable finish for extended life cycle and reduced maintenance costs.

Features & Advantages

- Protects door faces and edges
- Reduces the need for frequent repair, which takes time and can be costly
- Manufactured to custom specified sizes from 2 mm Acrovyn Sheet
- Available in a wide range of colours and finishes to coordinate with your interior design scheme
- Plates and channels or formed angles are utilised to create a highly protective finish to door faces and edges
- Full and partial height solutions available

Applications

- Areas requiring low-cost protection for interior doors against daily wear and tear, including corridors, back-of-house, hallways etc.

Colours & Texture



Solid Colours
36



Finishes
12



Texture
Suede

See reverse for details.



c-sgroup.eu/2575



Door Cladding

Door Cladding Options

Channels and plates

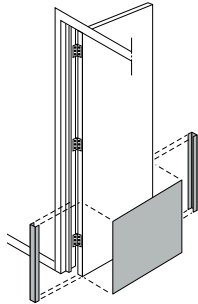

A combination of edge protection channels and plates.

Can be supplied in matching or contrasting colours.

- As standard, plates have straight edges for butting to channels
- Where plates are to be installed overlapping the channels, they can be supplied bevelled (round or 45° bevel is available)
- We recommend min. 20 mm leg size for channels

Door edges may have to be rebated to allow for sheet thickness.

Formed angles

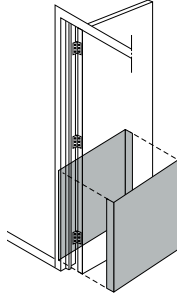

Two formed angles protect both edges and faces of the door.

Allowances have to be made for the thickness of sheet to ensure a good fit in the door frame. Rebating or adjusting is likely to be required, especially in partial height applications.

Application in wet areas

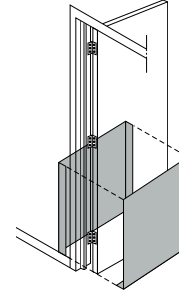

An angle and channel set covers both faces, vertical edges and the bottom edge of the door.

A suitable, moisture resistant adhesive must be used and any joints sealed to prevent moisture ingress.

Colour Selector

Solid Colours	LRV 86	LRV 83	LRV 74	LRV 73	LRV 80	LRV 49	LRV 39	LRV 50	LRV 63	LRV 50
	Snow White 9003	Pure White 9010	Mission White 933	Eggshell 100	Misty Grey 260	Dove Grey 24	Pearl Grey 136	Felt 7044	Ice Blue 1015	Aqua Blue 11
	LRV 64	LRV 40	LRV 24	LRV 7	LRV 22	LRV 14	LRV 10	LRV 8	LRV 32	LRV 24
	Grey Cloud 801	Tan Bark 187	Taupe 26	Earth 8019	Charcoal 162	Anthracite 7043	Graphite 7024	Black 108	Cape Blue 325	Pacific Blue 112
LRV 70	LRV 66	LRV 47	LRV 15	LRV 60	LRV 56	LRV 31	LRV 13	LRV 20	LRV 8	
French Cream 101	Golden Yellow 16	Tangerine 17	Spectrum Red 845	Almond Green 1510	Anise 22	Lagoon 5018	Sequoia Green 6020	Baltic Blue 4030	Yale Blue 129	
LRV 79	LRV 31	LRV 28	LRV 13	LRV 16	LRV 29					
Powder Pink 510	Coral Blush 2040	Pink Grapefruit 2050	Sugar Plum 32	Imperial Purple 520	Prairie Green 3040					
Finishes	LRV 54	LRV 37	LRV 27	LRV 40	LRV 18	LRV 10				
	Natural Oak 51	Golden Oak 52	Walnut 53	Bleached Oak 36	Smoked Oak 38	Wenge 39				
	LRV 30	LRV 33	LRV 31	LRV 43	LRV 25	LRV 10				
Brushed Metal 06	Bronze 57	Copper 58	Grey Concrete 54	Taupe Concrete 55	Black Concrete 56					

LRV (Light Reflectance Value) indicates the amount of light reflected by a surface and can be used to assess the degree of visual contrast between different surfaces. LRV values for Acrovyn colours have been determined using the CIE Y value measurement method.

Door Face Protection

Simple, economical solution for protecting the most used areas of new or existing doors from wear and tear, prolonging their life.

Features & Advantages

- Full or partial height protection of door faces*
- Manufactured to custom specified sizes from 2 mm Acrovyn Sheet
- Available in a wide range of colours and finishes to coordinate with your interior design scheme
- Plates have square edges as standard, or can be bevelled on request
- Available in rectangular shapes or a selection of standard decorative designs
- Custom shapes can be easily accommodated

Applications

- Areas requiring low-cost protection for interior doors against daily wear and tear, including corridors, back-of-house, hallways etc.

Colours & Texture



Solid Colours
36



Finishes
12



Texture
Suede

* Allowances need to be made to accommodate Acrovyn Sheet thickness in relation to the door frame to ensure a good fit.



c-sgroup.eu/2577



Door Face Protection

Standard Designs

Kick and/or push plates



- Rectangular
- Bespoke sizes
- Mix or match colours

Partial or full height



- Rectangular
- Full or partial height
- Bespoke sizes

01. Rainbow

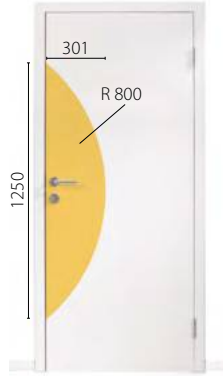

- LH and RH designs
- Bespoke sizes on request

02. Half moon



- 400 x 200 mm or 300 x 150 mm
- LH and RH door designs
- Bespoke sizes on request

03. Locate



- LH and RH designs
- Bespoke sizes on request
- One colour as standard (numbers cut out); number shapes at an extra cost

04. Rainbow with strip

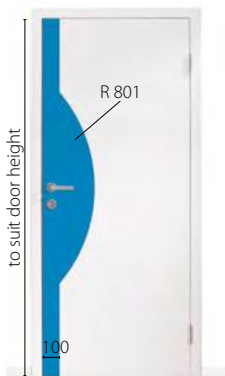

- LH and RH designs
- Bespoke sizes on request

05. Dune



- LH and RH designs in a range of widths
- Bespoke sizes on request

06. Wave



- LH and RH designs in a range of widths
- Bespoke sizes on request

07. Invert



- LH and RH designs in a range of widths
- Bespoke sizes on request
- Two-colour

08. Cityscape



- LH and RH designs in a range of widths
- Bespoke sizes on request

09. Ombre



- LH and RH designs in a range of widths
- Bespoke sizes on request
- Multi-colour (up to 5)

10. Valley



- LH and RH designs in a range of widths
- Bespoke sizes on request
- Multi-colour (up to 4)

Custom cutting



- Fully customised
- Designs to be supplied in a .dxf format.

Colour Options

For details of all available colours and finishes visit:

c-sgroup.eu/2445



Door Edge Protectors (DEPs)

Simple to install, robust and cost-effective solution for preventing damage to edges of new and existing timber core doors.

Features & Advantages

- Acrovyn DEPs can be installed to one or both edges of the door leaf
- Often used in combination with Acrovyn door face protection, installed either flush with it or overlapping
- Manufactured to suit 44 or 54 mm thick timber core doors as standard (other thicknesses can be accommodated*)
- Standard height 2100 mm (max. 2500 mm)
- Available in 36 colourways to suit different colour schemes and make it easy to meet visual contrast requirements
- Protects against daily wear and tear, prolonging the lifespan of the door
- Easy to replace in case of damage

Applications

- Areas where interior doors are seeing constant wear and tear along the edges and protection is desired

Colours & Texture



Solid Colours
36



Texture
Suede

See reverse for details.

** Tooling charges may apply. Contact us to discuss your requirements.*

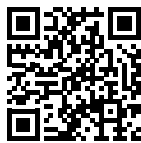

c-sgroup.eu/2579



Door Edge Protectors (DEPs)

Product Options

- Manufactured from 2 mm textured Acrovyn, DEPs incorporate 8 mm thick inner Acrovyn lipping
- Sizes to suit two standard door thicknesses

DE-01 (to suit 44 mm thick doors)

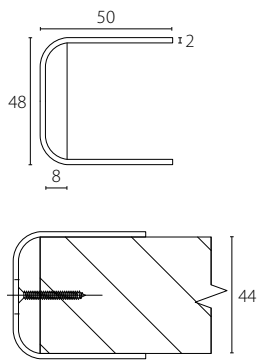

DE-06 (to suit 54 mm thick doors)

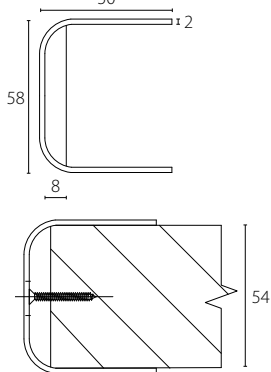

- Standard height 2100 mm (max. 2500 mm)
- Supplied without fixing holes, for installation flexibility (recommended fixing positions: 150 mm from top and bottom and at max 300 mm intervals in between)
- Supplied with fixings to suit timber core doors, and with colour matched pellets to conceal fixing positions

Installation Options



DEPs only

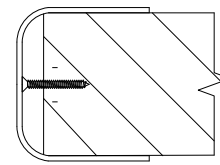

Installed to one or both edges of the door leaf.

DEPs installed flush with door face protection

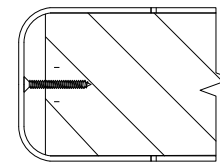





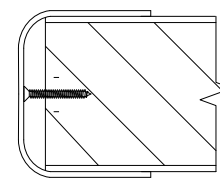































Colour-matched mastic can be used at the joints.

DEPs overlapping door face protection



DEPs are manufactured oversized, to allow for door face protection thickness.

Colour Selector

 LRV 86 Snow White 9003	 LRV 83 Pure White 9010	 LRV 74 Mission White 933	 LRV 73 Eggshell 100	 LRV 80 Misty Grey 260	 LRV 49 Dove Grey 24	 LRV 39 Pearl Grey 136	 LRV 50 Felt 7044	 LRV 63 Ice Blue 1015	 LRV 50 Aqua Blue 11
 LRV 64 Grey Cloud 801	 LRV 40 Tan Bark 187	 LRV 24 Taupe 26	 LRV 7 Earth 8019	 LRV 22 Charcoal 162	 LRV 14 Anthracite 7043	 LRV 10 Graphite 7024	 LRV 8 Black 108	 LRV 32 Cape Blue 325	 LRV 24 Pacific Blue 112
 LRV 70 French Cream 101	 LRV 66 Golden Yellow 16	 LRV 47 Tangerine 17	 LRV 15 Spectrum Red 845	 LRV 60 Almond Green 1510	 LRV 56 Anise 22	 LRV 31 Lagoon 5018	 LRV 13 Sequoia Green 6020	 LRV 20 Baltic Blue 4030	 LRV 8 Yale Blue 129
 LRV 79 Powder Pink 510	 LRV 31 Coral Blush 2040	 LRV 28 Pink Grapefruit 2050	 LRV 13 Sugar Plum 32	 LRV 16 Imperial Purple 520	 LRV 29 Prairie Green 3040	<p><i>LRV (Light Reflectance Value) indicates the amount of light reflected by a surface and can be used to assess the degree of visual contrast between different surfaces. LRV values for Acrovyn colours have been determined using the CIE Y value measurement method.</i></p>			

Door Frame Protection

An effective, custom-formed solution protecting timber or metal door frames and architraves from constant wear and tear.

Features & Advantages

- Made to customer-specified sizes from 2 mm Acrovyn Sheet
- Built from a series of formed channel and angle sections to provide frame or architrave protection
- Channels can be supplied to suit square or rounded edge sections *
- Reduces the need for constant repair and painting, which takes time and can be costly
- Extends the lifespan of the frame

** Tooling charges may apply. Contact us to discuss your requirements*

Applications

- Interior areas that see constant wear & tear on door frames and architraves

Colours & Texture



Solid Colours
36



Finishes
12



Texture
Suede

See reverse for details.



c-sgroup.eu/2578



Door Frame Protection

Frame Protection Examples

Combination of channels and/or angles in bespoke sizes to suit frame shape.

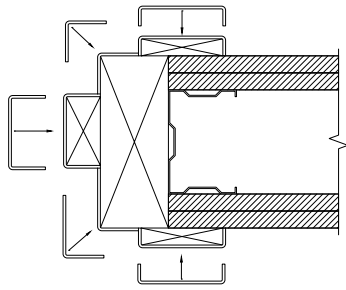

Example timber frame protection

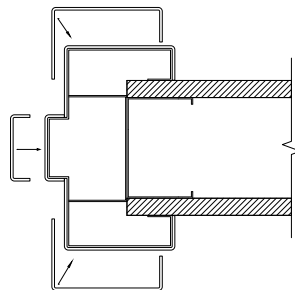

Example metal frame protection

Sheet thickness should be taken into account in calculation of sizes. We will require internal dimensions of the frame protection required.

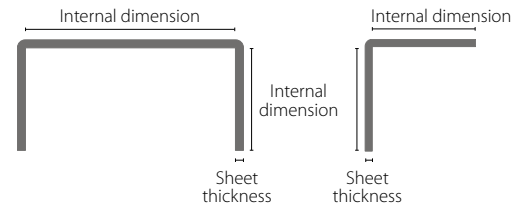

Channel

Angle

Colour Selector

Solid Colours										
Finishes										

LRV (Light Reflectance Value) indicates the amount of light reflected by a surface and can be used to assess the degree of visual contrast between different surfaces. LRV values for Acrovyn colours have been determined using the CIE Y value measurement method.

Door Cladding

Bespoke manufactured Acrovyn PVC-Free Door Cladding creates a highly durable finish for extended life cycle and reduced maintenance costs.

Features & Advantages

- Protects door faces and edges
- Reduces the need for frequent repair, which takes time and can be costly
- Manufactured to custom specified sizes from 1.5 mm Acrovyn PVC-Free Sheet
- Available in a wide range of colours to coordinate with your interior design scheme
- Plates and channels or formed angles are utilised to create a highly protective finish to door faces and edges
- Full and partial height solutions available

Applications

- Areas requiring low-cost protection for interior doors against daily wear and tear, including corridors, back-of-house, hallways etc.

Colours & Texture



Solid Colours
36



Texture
Suede

See reverse for details.



c-sgroup.eu/2575



Door Cladding

Door Cladding Options

Channels and plates

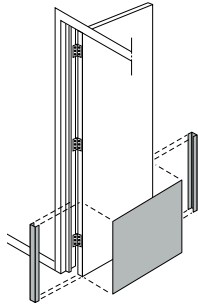

A combination of edge protection channels and plates.

Can be supplied in matching or contrasting colours.

- As standard, plates have straight edges for butting to channels
- Where plates are to be installed overlapping the channels, they can be supplied bevelled (round or 45° bevel is available)
- We recommend min. 20 mm leg size for channels

Door edges may have to be rebated to allow for sheet thickness.

Formed angles

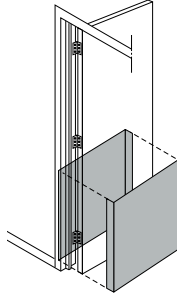

Two formed angles protect both edges and faces of the door.

Allowances have to be made for the thickness of sheet to ensure a good fit in the door frame. Rebating or adjusting is likely to be required, especially in partial height applications.



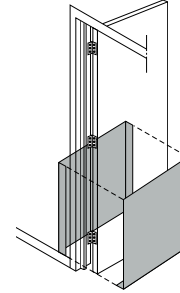

































Application in wet areas



An angle and channel set covers both faces, vertical edges and the bottom edge of the door.

A suitable, moisture resistant adhesive must be used and any joints sealed to prevent moisture ingress.

Colour Selector

 LRV 86 Snow White 9003	 LRV 83 Pure White 9010	 LRV 74 Mission White 933	 LRV 73 Eggshell 100	 LRV 80 Misty Grey 260	 LRV 49 Dove Grey 24	 LRV 39 Pearl Grey 136	 LRV 50 Felt 7044	 LRV 63 Ice Blue 1015	 LRV 50 Aqua Blue 11
 LRV 64 Grey Cloud 801	 LRV 40 Tan Bark 187	 LRV 24 Taupe 26	 LRV 7 Earth 8019	 LRV 22 Charcoal 162	 LRV 14 Anthracite 7043	 LRV 10 Graphite 7024	 LRV 8 Black 108	 LRV 32 Cape Blue 325	 LRV 24 Pacific Blue 112
 LRV 70 French Cream 101	 LRV 66 Golden Yellow 16	 LRV 47 Tangerine 17	 LRV 15 Spectrum Red 845	 LRV 60 Almond Green 1510	 LRV 56 Anise 22	 LRV 31 Lagoon 5018	 LRV 13 Sequoia Green 6020	 LRV 20 Baltic Blue 4030	 LRV 8 Yale Blue 129
 LRV 79 Powder Pink 510	 LRV 31 Coral Blush 2040	 LRV 28 Pink Grapefruit 2050	 LRV 13 Sugar Plum 32	 LRV 16 Imperial Purple 520	 LRV 29 Prairie Green 3040				

LRV (Light Reflectance Value) indicates the amount of light reflected by a surface and can be used to assess the degree of visual contrast between different surfaces. LRV values for Acrovyn colours have been determined using the CIE Y value measurement method.

Door Face Protection

Simple, economical solution for protecting the most used areas of new or existing doors from wear and tear, prolonging their life.

Features & Advantages

- Full or partial height protection of door faces*
- Manufactured to custom specified sizes from 1.5 mm Acrovyn PVC-Free Sheet or 1 mm Acrovyn by Design
- Available in a wide range of colours to coordinate with your interior design scheme, or can incorporate bespoke imagery or patterns
- Plates have square edges as standard, or can be bevelled on request
- Available in rectangular shapes or a selection of standard decorative designs
- Custom shapes can be easily accommodated

Applications

- Areas requiring low-cost protection for interior doors against daily wear and tear, including corridors, back-of-house, hallways etc.

Colours & Texture



Solid Colours
36



Acrovyn by Design
Bespoke imagery



Texture
Suede

* Allowances need to be made to accommodate Acrovyn Sheet thickness in relation to the door frame to ensure a good fit.



c-sgroup.eu/2577



Door Face Protection

Standard Designs

Kick and/or push plates



- Rectangular
- Bespoke sizes
- Mix or match colours

Partial or full height



- Rectangular
- Full or partial height
- Bespoke sizes

01. Rainbow

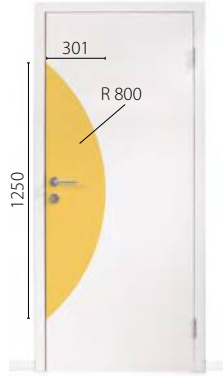

- LH and RH designs
- Bespoke sizes on request

02. Half moon



- 400 x 200 mm or 300 x 150 mm
- LH and RH door designs
- Bespoke sizes on request

03. Locate



- LH and RH designs
- Bespoke sizes on request
- One colour as standard (numbers cut out); number shapes at an extra cost

04. Rainbow with strip

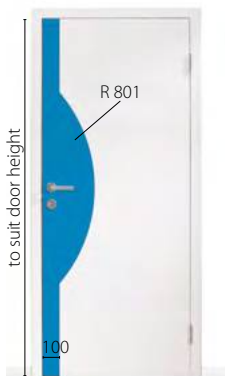

- LH and RH designs
- Bespoke sizes on request

05. Dune



- LH and RH designs in a range of widths
- Bespoke sizes on request

06. Wave



- LH and RH designs in a range of widths
- Bespoke sizes on request

07. Invert



- LH and RH designs in a range of widths
- Bespoke sizes on request
- Two-colour

08. Cityscape



- LH and RH designs in a range of widths
- Bespoke sizes on request

09. Ombre



- LH and RH designs in a range of widths
- Bespoke sizes on request
- Multi-colour (up to 5)

10. Valley



- LH and RH designs in a range of widths
- Bespoke sizes on request
- Multi-colour (up to 4)

Custom cutting



- Fully customised
- Designs to be supplied in a .dxf format.

Acrovyn by Design



- Printed with customer-supplied photos/graphics
- Bespoke sizes

Colour Options

For details of standard solid colours visit:

c-sgroup.eu/2445



Door Frame Protection

An effective, custom-formed solution protecting timber or metal door frames and architraves from constant wear and tear.

Features & Advantages

- Made to customer-specified sizes from 1.5 mm Acrovyn PVC-Free Sheet
- Built from a series of formed channel and angle sections to provide frame or architrave protection
- Channels can be supplied to suit square or rounded edge sections *
- Reduces the need for constant repair and painting, which takes time and can be costly
- Extends the lifespan of the frame

* Tooling charges may apply. Contact us to discuss your requirements

Applications

- Interior areas that see constant wear & tear on door frames and architraves

Colours & Texture



Solid Colours
36



Texture
Suede

See reverse for details.



c-sgroup.eu/2578



Door Frame Protection

Frame Protection Examples

Combination of channels and/or angles in bespoke sizes to suit frame shape.

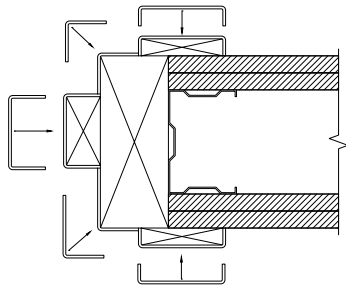

Example timber frame protection

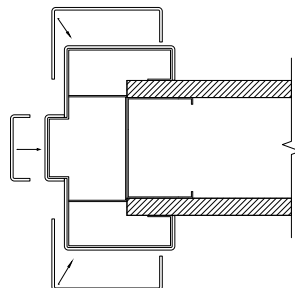

Example metal frame protection

Sheet thickness should be taken into account in calculation of sizes. We will require internal dimensions of the frame protection required.

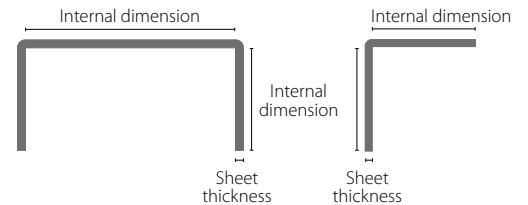

Channel

Angle

Colour Selector

Solid Colours	LRV 86	LRV 83	LRV 74	LRV 73	LRV 80	LRV 49	LRV 39	LRV 50	LRV 63	LRV 50
	Snow White 9003	Pure White 9010	Mission White 933	Eggshell 100	Misty Grey 260	Dove Grey 24	Pearl Grey 136	Felt 7044	Ice Blue 1015	Aqua Blue 11
	LRV 64	LRV 40	LRV 24	LRV 7	LRV 22	LRV 14	LRV 10	LRV 8	LRV 32	LRV 24
	Grey Cloud 801	Tan Bark 187	Taupe 26	Earth 8019	Charcoal 162	Anthracite 7043	Graphite 7024	Black 108	Cape Blue 325	Pacific Blue 112
LRV 70	LRV 66	LRV 47	LRV 15	LRV 60	LRV 56	LRV 31	LRV 13	LRV 20	LRV 8	
French Cream 101	Golden Yellow 16	Tangerine 17	Spectrum Red 845	Almond Green 1510	Anise 22	Lagoon 5018	Sequoia Green 6020	Baltic Blue 4030	Yale Blue 129	
LRV 79	LRV 31	LRV 28	LRV 13	LRV 16	LRV 29					
Powder Pink 510	Coral Blush 2040	Pink Grapefruit 2050	Sugar Plum 32	Imperial Purple 520	Prairie Green 3040					

LRV (Light Reflectance Value) indicates the amount of light reflected by a surface and can be used to assess the degree of visual contrast between different surfaces. LRV values for Acrovyn colours have been determined using the CIE Y value measurement method.

Acrovyn®
Colours



Acrovyn® PVC - Solid Colours



Our wide palette of colours includes timeless classics and on-trend shades, allowing you to express your creativity and breathe new life into commercial interiors.

Inspired by the natural world around us, the palette is a curated selection of tones and hues that can provide any space with a fresh, modern look. Design with colour schemes that set the mood, elevate comfort, and enhance experiences with your style, from hints of light and warm neutrals, subtle tones of calming greens and blues, to bold reds and yellows that evoke an energising feel.

The complete selection of standard colours is available in our impact resistant textured sheet, as well as stick-on corner guards and rub rails which are often specified with it. All other Acrovyn Profiles, such as handrails, crash rails or bed head protectors are available in a comprehensive range of our most popular colours to allow you to create beautifully co-ordinated interiors that last.



c-sgroup.eu/17129

Acrovyn® PVC - Solid Colours

Colour Selector

 <p>LRV 86 RAL 9003 NCS S 0500-N</p>	 <p>LRV 64 RAL 080 80 05 NCS S 1502-Y50R</p>	 <p>LRV 50 RAL 7044 NCS S 2502-Y</p>	 <p>LRV 80 RAL 280 90 05 NCS S 0505-R80B</p>	 <p>LRV 63 RAL 260 80 10 NCS S 1015-R80B</p>
Snow White 9003	Grey Cloud 801	Felt 7044	Misty Grey 260	Ice Blue 1015
 <p>LRV 83 RAL 9010 NCS S 0502-G</p>	 <p>LRV 40 RAL 070 70 10 NCS S 3005-Y50R</p>	 <p>LRV 39 RAL 7037 NCS S 3500-N</p>	 <p>LRV 49 RAL 200 70 05 NCS S 2502-B</p>	 <p>LRV 50 RAL 250 80 20 NCS S 1030-R90B</p>
Pure White 9010	Tan Bark 187	Pearl Grey 136	Dove Grey 24	Aqua Blue 11
 <p>LRV 74 RAL 9001 NCS S 1002-Y50R</p>	 <p>LRV 24 RAL 060 50 05 NCS S 5005-Y80R</p>	 <p>LRV 22 RAL 7037 NCS S 5500-N</p>	 <p>LRV 10 RAL 7024 NCS S 7502-B</p>	 <p>LRV 24 RAL 5012 NCS S 1560-R90B</p>
Mission White 933	Taupe 26	Charcoal 162	Graphite 7024	Pacific Blue 112
 <p>LRV 73 RAL 1013 NCS S 1005-Y10R</p>	 <p>LRV 7 RAL 8019 NCS S 8005-Y80R</p>	 <p>LRV 14 RAL 7043 NCS S 7000-N</p>	 <p>LRV 8 RAL 7021 NCS S 8000-N</p>	 <p>LRV 8 RAL 5001 NCS S 6030-R90B</p>
Eggshell 100	Earth 8019	Anthracite 7043	Black 108	Yale Blue 129
 <p>LRV 70 RAL 1015 NCS S 1010-Y20R</p>	 <p>LRV 79 RAL 350 90 05 NCS S 0507-R20B</p>	 <p>LRV 60 RAL 180 80 05 NCS S 1510-B80G</p>	 <p>LRV 29 RAL 130 60 30 NCS S 3040-G30Y</p>	 <p>LRV 20 RAL 230 50 20 NCS S 4030-B10G</p>
French Cream 101	Powder Pink 510	Almond Green 1510	Prairie Green 3040	Baltic Blue 4030
 <p>LRV 66 RAL 080 80 70 NCS S 0560-Y10R</p>	 <p>LRV 31 RAL 020 60 30 NCS S 2040-R</p>	 <p>LRV 56 RAL 110 80 40 NCS S 1040-G40Y</p>	 <p>LRV 13 RAL 200 40 10 NCS S 6020-B50G</p>	 <p>LRV 31 RAL 5018 NCS S 2050-B30G</p>
Golden Yellow 16	Coral Blush 2040	Anise 22	Sequoia Green 6020	Lagoon 5018
 <p>LRV 47 RAL 060 70 70 NCS S 1060-Y30R</p>	 <p>LRV 28 RAL 030 60 40 NCS S 2050-Y80R</p>	 <p>LRV 32 RAL 240 60 15 NCS S 3020-R90B</p>	<p>Full colour range is available in Acrovyn Textured Sheet, Acrovyn Door Protection, SO Series Corner Guards, TP Series Rub Rails and Acrovyn Wall Panels.</p> <p>Models available in a limited colour range are indicated as follows:</p> <ul style="list-style-type: none"> (AS) Acrovyn Smooth Sheet - 10 colours (BS) Acrovyn Bactericide Sheet - Smooth - 1 colour (BT) Acrovyn Bactericide Sheet - Textured - 6 colours (P) Acrovyn Profiles (except SO and TP Series) - 27 colours <p>LRVs (Light Reflectance Values) for our colours have been determined using the CIE Y value measurement method.</p> <p>RAL and NCS colours indicated are nearest matches (7-digit RAL references are part of the RAL Design range).</p>	
Tangerine 17	Pink Grapefruit 2050	Cape Blue 325		
 <p>LRV 15 RAL 3020 NCS S 2070-Y90R</p>	 <p>LRV 13 RAL 350 30 30 NCS S 4040-R30B</p>	 <p>LRV 16 RAL 290 50 15 NCS S 5020-R60B</p>		
Spectrum Red 845	Sugar Plum 32	Imperial Purple 520		

Due to limitations of computer screens actual Acrovyn colours may vary. Please request samples prior to specifying.

Acrovyn® PVC - Decorative Finishes



Our refreshed palette of decorative finishes is available in a range of product options, allowing you to design beautiful and well protected spaces.

Bring depth and a calming sense of nature to the interior with our natural looking woodgrains. Now available in on-trend bleached effects, as well as timeless oak and walnut options.

Choose our concrete patterns for a simple and modern effect. They will work equally well when paired with neutral shades, woodgrains or splashes of bright colours.

Where a touch of sophistication is desired in your spaces, our new iridescent Copper and Bronze finishes will deliver the look without the price tag.



c-sgroup.eu/17129

Acrovyn® PVC - Decorative Finishes

Colour Selector

Woodgrains



Natural Oak 51



Bleached Oak 36



Golden Oak 52

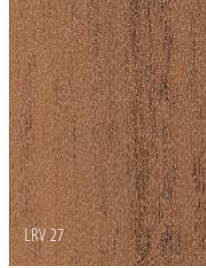

Walnut 53



Smoked Oak 38



Wenge 39

Metals

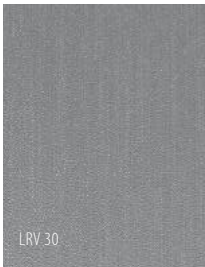

Brushed Metal 06



Bronze 57



Copper 58

Concretes



Grey Concrete 54



Taupe Concrete 55



Black Concrete 56

LRVs (Light Reflectance Values) for our colours have been determined using the CIE Y value measurement method.

Product Availability

Decorative Finishes can be specified for 2 mm Acrovyn Textured Sheet and the following Acrovyn PVC Profiles:



HRE-6 Handrail



HRO-6 Handrail



HRB-20 Hand/Crash Rail
(handrail section only)



SCR-80 Crash Rail



SSM-20 Corner Guard

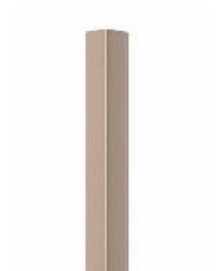

SO-50 Corner Guard

Due to limitations of computer screens actual Acrovyn colours may vary. Please request samples prior to specifying.

Acrovyn® PVC-Free - Solid Colours

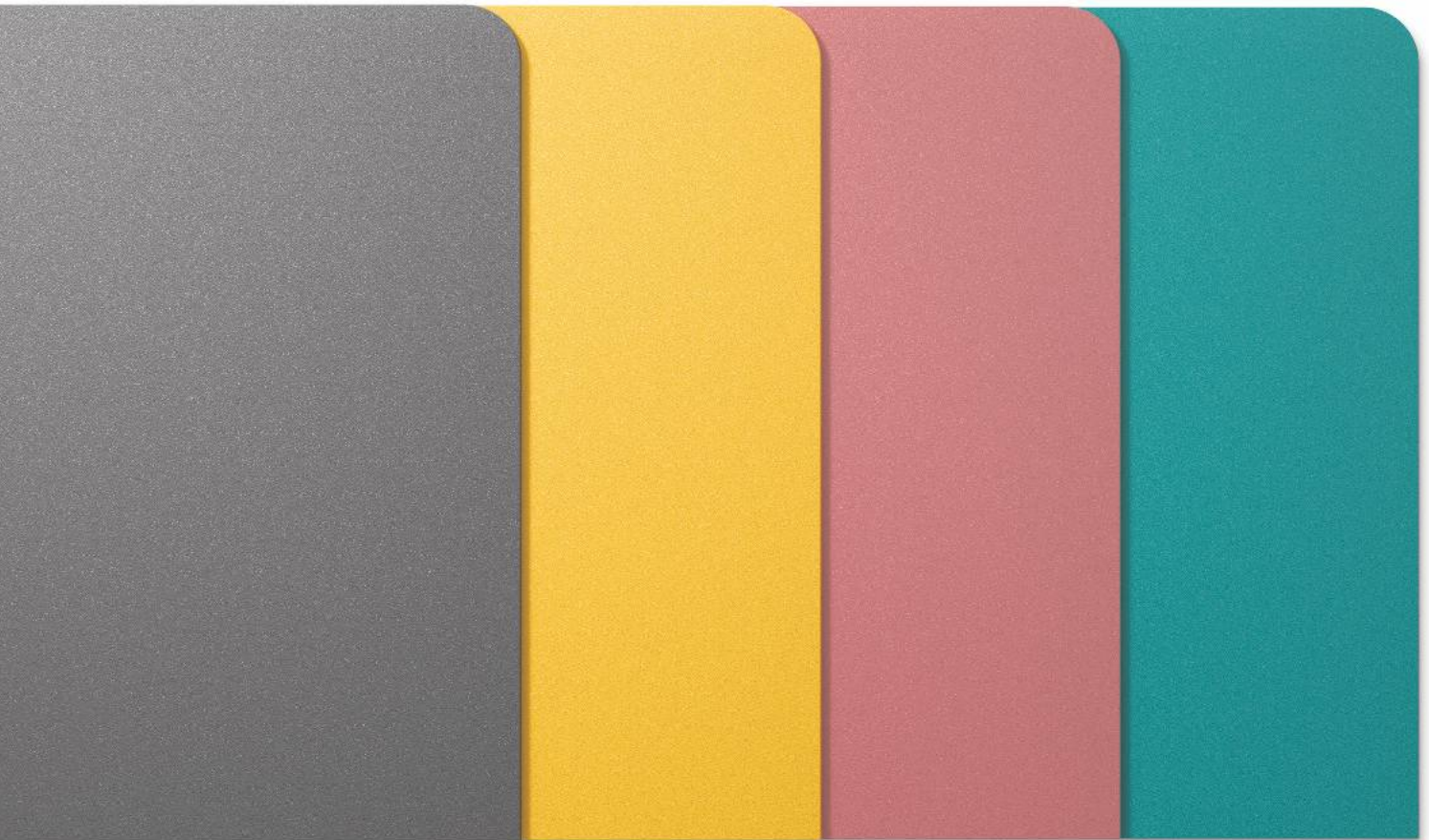

Our wide palette of colours includes timeless classics and on-trend shades, allowing you to express your creativity and breathe new life into commercial interiors.

Inspired by the natural world around us, the palette is a curated selection of tones and hues that can provide any space with a fresh, modern look. Design with colour schemes that set the mood, elevate comfort, and enhance experiences with your style, from hints of light and warm neutrals, subtle tones of calming greens and blues, to bold reds and yellows that evoke an energising feel.

Choose from the full selection of colourways when specifying our impact resistant textured sheet and thermoformed corner guards. Where wall protection profiles are required in your interiors to guard parts of the wall from damage or provide sturdy pedestrian support, our range of PVC-Free profile colours will allow you to create beautifully co-ordinated interiors that last.



c-sgroup.eu/2581

Acrovyn® PVC-Free - Solid Colours

Colour Selector

<p>LRV 86 RAL 9003 NCS S 0500-N</p>	<p>LRV 64 RAL 080 80 05 NCS S 1502-Y50R</p>	<p>LRV 50 RAL 7044 NCS S 2502-Y</p>	<p>LRV 80 RAL 280 90 05 NCS S 0505-R80B</p>	<p>LRV 63 RAL 260 80 10 NCS S 1015-R80B</p>
Snow White 9003	Grey Cloud 801	Felt 7044	Misty Grey 260	Ice Blue 1015
<p>LRV 83 RAL 9010 NCS S 0502-G</p>	<p>LRV 40 RAL 070 70 10 NCS S 3005-Y50R</p>	<p>LRV 39 RAL 7004 NCS S 3500-N</p>	<p>LRV 49 RAL 200 70 05 NCS S 2502-B</p>	<p>LRV 50 RAL 250 80 20 NCS S 1030-R90B</p>
Pure White 9010	Tan Bark 187	Pearl Grey 136	Dove Grey 24	Aqua Blue 11
<p>LRV 74 RAL 9001 NCS S 1002-Y50R</p>	<p>LRV 24 RAL 060 50 05 NCS S 5005-Y80R</p>	<p>LRV 22 RAL 7037 NCS S 5500-N</p>	<p>LRV 10 RAL 7024 NCS S 7502-B</p>	<p>LRV 24 RAL 5012 NCS S 1560-R90B</p>
Mission White 933	Taupe 26	Charcoal 162	Graphite 7024	Pacific Blue 112
<p>LRV 73 RAL 1013 NCS S 1005-Y10R</p>	<p>LRV 7 RAL 8019 NCS S 8005-Y80R</p>	<p>LRV 14 RAL 7043 NCS S 7000-N</p>	<p>LRV 8 RAL 7021 NCS S 8000-N</p>	<p>LRV 8 RAL 5001 NCS S 6030-R90B</p>
Eggshell 100	Earth 8019	Anthracite 7043	Black 108	Yale Blue 129
<p>LRV 70 RAL 1015 NCS S 1010-Y20R</p>	<p>LRV 79 RAL 350 90 05 NCS S 0507-R20B</p>	<p>LRV 60 RAL 180 80 05 NCS S 1510-B80G</p>	<p>LRV 29 RAL 130 60 30 NCS S 3040-G30Y</p>	<p>LRV 20 RAL 230 50 20 NCS S 4030-B10G</p>
French Cream 101	Powder Pink 510	Almond Green 1510	Prairie Green 3040	Baltic Blue 4030
<p>LRV 66 RAL 080 80 70 NCS S 0560-Y10R</p>	<p>LRV 31 RAL 020 60 30 NCS S 2040-R</p>	<p>LRV 56 RAL 110 80 40 NCS S 1040-G40Y</p>	<p>LRV 13 RAL 200 40 10 NCS S 6020-B50G</p>	<p>LRV 31 RAL 5018 NCS S 2050-B30G</p>
Golden Yellow 16	Coral Blush 2040	Anise 22	Sequoia Green 6020	Lagoon 5018
<p>LRV 47 RAL 060 70 70 NCS S 1060-Y30R</p>	<p>LRV 28 RAL 030 60 40 NCS S 2050-Y80R</p>	<p>LRV 32 RAL 240 60 15 NCS S 3020-R90B</p>	<p>LRV 90 RAL 9003 NCS S 0300-N</p>	<p>LRV 90 RAL 9003 NCS S 0300-N</p>
Tangerine 17	Pink Grapefruit 2050	Cape Blue 325	Imperial Purple 520	White 949 - standard for Profiles
<p>LRV 15 RAL 3020 NCS S 2070-Y90R</p>	<p>LRV 13 RAL 350 30 30 NCS S 4040-R30B</p>	<p>LRV 16 RAL 290 50 15 NCS S 5020-R60B</p>	<p>LRV 16 RAL 290 50 15 NCS S 5020-R60B</p>	<p>LRV 90 RAL 9003 NCS S 0300-N</p>
Spectrum Red 845	Sugar Plum 32	Imperial Purple 520		

Acrovyn PVC-Free Textured Sheet, TF-N Corner Guards and Acrovyn PVC-Free Wall Panels are available in 36 standard colours.

P Indicates standard colours for PVC-Free Profiles

In addition, profiles are available in our brightest white - White 949.

LRVs (Light Reflectance Values) for our colours have been determined using the CIE Y value measurement method.

RAL and NCS colours indicated are nearest matches (7-digit RAL references are part of the RAL Design range).

Due to limitations of computer screens actual Acrovyn colours may vary. Please request samples prior to specifying.

People.
Buildings.
Better.

CS FRANCE

135, Rue Edouard Isambard,
B.P. 66 | 27120 Pacy-sur-Eure Cedex
FRANCE

Tel: +33 2 32 67 00 00
information@c-sgroup.com
c-sgroup.eu

